



GREENWORKS SERVICE COMPANY

855-349-6757

support@greenworksinspections.com

<https://greenworksinspections.com>



GW STANDARD HOME INSPECTION

[REDACTED]

[REDACTED]



Inspector

[REDACTED]

[REDACTED]

[REDACTED]

[REDACTED]

[REDACTED]



Agent

[REDACTED]







[REDACTED]

[REDACTED]

[REDACTED]



PROPERTY INSPECTION REPORT FORM

 Name of Client	03/15/2023 9:30 am Date of Inspection
 Address of Inspected Property	
 Name of Inspector	 TREC License #
 Name of Sponsor (if applicable)	 TREC License #

PURPOSE OF INSPECTION

A real estate inspection is a visual survey of a structure and a basic performance evaluation of the systems and components of a building. It provides information regarding the general condition of a residence at the time the inspection was conducted. *It is important* that you carefully read ALL of this information. Ask the inspector to clarify any items or comments that are unclear.

RESPONSIBILITY OF THE INSPECTOR

This inspection is governed by the Texas Real Estate Commission (TREC) Standards of Practice (SOPs), which dictates the minimum requirements for a real estate inspection.

The inspector IS required to:

- use this Property Inspection Report form for the inspection;
- inspect only those components and conditions that are present, visible, and accessible at the time of the inspection;
- indicate whether each item was inspected, not inspected, or not present;
- indicate an item as Deficient (D) if a condition exists that adversely and materially affects the performance of a system or component **OR** constitutes a hazard to life, limb or property as specified by the SOPs; and
- explain the inspector's findings in the corresponding section in the body of the report form.

The inspector IS NOT required to:

- identify all potential hazards;
- turn on decommissioned equipment, systems, utilities, or apply an open flame or light a pilot to operate any appliance;
- climb over obstacles, move furnishings or stored items;
- prioritize or emphasize the importance of one deficiency over another;
- provide follow-up services to verify that proper repairs have been made; or
- inspect system or component listed under the optional section of the SOPs (22 TAC 535.233).

RESPONSIBILITY OF THE CLIENT

While items identified as Deficient (D) in an inspection report DO NOT obligate any party to make repairs or take other actions, in the event that any further evaluations are needed, it is the responsibility of the client to obtain further evaluations and/or cost estimates from qualified service professionals regarding any items reported as Deficient (D). It is recommended that any further evaluations and/or cost estimates take place prior to the expiration of any contractual time limitations, such as option periods.

Please Note: Evaluations performed by service professionals in response to items reported as Deficient (D) on the report may lead to the discovery of additional deficiencies that were not present, visible, or accessible at the time of the inspection. Any repairs made after the date of the inspection may render information contained in this report obsolete or invalid.

REPORT LIMITATIONS

This report is provided for the benefit of the named client and is based on observations made by the named inspector on the date the inspection was performed (indicated above).

ONLY those items specifically noted as being inspected on the report were inspected.

This inspection IS NOT:

- a technically exhaustive inspection of the structure, its systems, or its components and may not reveal all deficiencies;
- an inspection to verify compliance with any building codes;
- an inspection to verify compliance with manufacturer's installation instructions for any system or component and DOES NOT imply insurability or warrantability of the structure or its components.

NOTICE CONCERNING HAZARDOUS CONDITIONS, DEFICIENCIES, AND CONTRACTUAL AGREEMENTS

Conditions may be present in your home that did not violate building codes or common practices in effect when the home was constructed but are considered hazardous by today's standards. Such conditions that were part of the home prior to the adoption of any current codes prohibiting them may not be required to be updated to meet current code requirements. However, if it can be reasonably determined that they are present at the time of the inspection, the potential for injury or property loss from these conditions is significant enough to require inspectors to report them as Deficient (D). Examples of such hazardous conditions include:

- malfunctioning, improperly installed, or missing ground fault circuit protection (GFCI) devices and arc-fault (AFCI) devices;
- ordinary glass in locations where modern construction techniques call for safety glass;
- malfunctioning or lack of fire safety features such as smoke alarms, fire-rated doors in certain locations, and functional emergency escape and rescue openings in bedrooms;
- malfunctioning carbon monoxide alarms;
- excessive spacing between balusters on stairways and porches;
- improperly installed appliances;
- improperly installed or defective safety devices;
- lack of electrical bonding and grounding; and
- lack of bonding on gas piping, including corrugated stainless steel tubing (CSST).

Please Note: items identified as Deficient (D) in an inspection report DO NOT obligate any party to make repairs or take other actions. The decision to correct a hazard or any deficiency identified in an inspection report is left up to the parties to the contract for the sale or purchase of the home.

This property inspection report may include an inspection agreement (contract), addenda, and other information related to property conditions.

INFORMATION INCLUDED UNDER "ADDITIONAL INFORMATION PROVIDED BY INSPECTOR", OR PROVIDED AS AN ATTACHMENT WITH THE STANDARD FORM, IS NOT REQUIRED BY THE COMMISSION AND MAY CONTAIN CONTRACTUAL TERMS BETWEEN THE INSPECTOR AND YOU, AS THE CLIENT. THE COMMISSION DOES NOT REGULATE CONTRACTUAL TERMS BETWEEN PARTIES. IF YOU DO NOT UNDERSTAND THE EFFECT OF ANY CONTRACTUAL TERM CONTAINED IN THIS SECTION OR ANY ATTACHMENTS, CONSULT AN ATTORNEY.

ADDITIONAL INFORMATION PROVIDED BY INSPECTOR

PURPOSE, LIMITATIONS AND INSPECTOR / CLIENT RESPONSIBILITIES

This property inspection report may include an inspection agreement (contract), addenda, and other information related to property conditions. If any item or comment is unclear, you should ask the inspector to clarify the findings. It is important that you carefully read ALL of this information.

This inspection is subject to the rules ("Rules") of the Texas Real Estate Commission ("TREC"), which can be found at www.trec.texas.gov.

The TREC Standards of Practice (Sections 535.227-535.233 of the Rules) are the minimum standards for inspections by TREC-licensed inspectors. An inspection addresses only those components and conditions that are present, visible, and accessible at the time of the inspection. While there may be other parts, components or systems present, only those items specifically noted as being inspected were inspected. The inspector is NOT required to turn on decommissioned equipment, systems, utility services or apply an open flame or light a pilot to operate any appliance. The inspector is NOT required to climb over obstacles, move furnishings or stored items. The inspection report may address issues that are code-based or may refer to a particular code; however, this is NOT a code compliance inspection and does NOT verify compliance with manufacturer's installation instructions. The inspection does NOT imply insurability or warrantability of the structure or its components. Although some safety issues may be addressed in this report, this inspection is NOT a safety/code inspection, and the inspector is NOT required to identify all potential hazards.

In this report, the inspector shall indicate, by checking the appropriate boxes on the form, whether each item was inspected, not inspected, not present or deficient and explain the findings in the corresponding section in the body of the report form. The inspector must check the Deficient (D) box if a condition exists that adversely and materially affects the performance of a system or component or constitutes a hazard to life, limb or property as specified by the TREC Standards of Practice. General deficiencies include inoperability, material distress, water penetration, damage, deterioration, missing components, and unsuitable installation. Comments may be provided by the inspector whether or not an item is deemed deficient. The inspector is not required to prioritize or emphasize the importance of one deficiency over another.

Some items reported may be considered life-safety upgrades to the property. For more information, refer to Texas Real Estate Consumer Notice Concerning Recognized Hazards or Deficiencies below.

THIS PROPERTY INSPECTION IS NOT A TECHNICALLY EXHAUSTIVE INSPECTION OF THE STRUCTURE, SYSTEMS OR COMPONENTS. The inspection may not reveal all deficiencies. A real estate inspection helps to reduce some of the risk involved in purchasing a home, but it cannot eliminate these risks, nor can the inspection anticipate future events or changes in performance due to changes in use or occupancy. It is recommended that you obtain as much information as is available about this property, including any seller's disclosures, previous inspection reports, engineering reports, building/remodeling permits, and reports performed for or by relocation companies, municipal inspection departments, lenders, insurers, and appraisers. You should also attempt to determine whether repairs, renovation, remodeling, additions, or other such activities have taken place at this property. It is not the inspector's responsibility to confirm that information obtained from these sources is complete or accurate or that this inspection is consistent with the opinions expressed in previous or future reports.

ITEMS IDENTIFIED IN THE REPORT DO NOT OBLIGATE ANY PARTY TO MAKE REPAIRS OR TAKE OTHER ACTIONS, NOR IS THE PURCHASER REQUIRED TO REQUEST THAT THE SELLER TAKE ANY ACTION. When a deficiency is reported, it is the client's responsibility to obtain further evaluations and/or cost estimates from qualified service professionals. Any such follow-up should take place prior to the expiration of any time limitations such as option periods. Evaluations by qualified tradesmen may lead to the discovery of additional deficiencies which may involve additional repair costs. Failure to address deficiencies or comments noted in this report may lead to further damage of the structure or systems and add to the original repair costs. The inspector is not required to provide follow-up services to verify that proper repairs have been made.

When a deficiency is reported, it is the client's responsibility to obtain further evaluations and/or cost estimates from qualified and licensed (if applicable) service professionals. Property conditions change with time and use. For example, mechanical devices can fail at any time, plumbing gaskets and seals may crack if the appliance or plumbing fixture is not used often, roof leaks can occur at any time regardless of the apparent condition of the roof, and the performance of the structure and the systems may change due to changes in use or occupancy, effects of weather, etc. These changes or repairs made to the structure after the inspection may render information contained herein obsolete or invalid. This report is provided for the specific benefit of the client named above and is based on observations at the time of the inspection. If you did not hire the inspector yourself, reliance on this report may provide incomplete or outdated information. Repairs, professional opinions or additional inspection reports may affect the meaning of the information in this report. It is recommended that you hire a licensed inspector to perform an inspection to meet your specific needs and to provide you with current information concerning this property.

TEXAS REAL ESTATE CONSUMER NOTICE CONCERNING HAZARDS OR DEFICIENCIES

Each year, Texans sustain property damage and are injured by accidents in the home. While some accidents may not be avoidable, many other accidents, injuries, and deaths may be avoided through the identification and repair of certain hazardous conditions. Examples of such hazards include:

- malfunctioning, improperly installed or missing ground fault circuit protection (GFCI) devices for electrical receptacles in garages, bathroom, kitchens, and exterior areas;
- malfunctioning arc fault protection (AFCI) devices;
- ordinary glass in locations where modern construction techniques call for safety glass;
- malfunctioning or lack of fire safety features such as, smoke alarms, fire-rated doors in certain locations,

and functional emergency escape and rescue openings in bedrooms;
malfunctioning carbon monoxide alarms;
excessive spacing between balusters on stairways and porches;
improperly installed appliances;
improperly installed or defective safety devices;
lack of electrical bonding and grounding; and
lack of bonding on gas piping, including corrugated stainless steel tubing (CSST).

To ensure that consumers are informed of hazards such as these, the Texas Real Estate Commission (TREC) has adopted Standards of Practice requiring licensed inspectors to report these conditions as "Deficient" when performing an inspection for a buyer or seller, if they can be reasonably determined.

These conditions may not have violated building codes or common practices at the time of the construction of the home, or they may have been "grandfathered" because they were present prior to the adoption of codes prohibiting such conditions. While the TREC Standards of Practice do not require inspectors to perform a code compliance inspection, TREC considers the potential for injury or property loss from the hazards addressed in the Standards of Practice to be significant enough to warrant this notice.

Contract forms developed by TREC for use by its real estate licensees also inform the buyer of the right to have the home inspected and can provide an option clause permitting the buyer to terminate the contract within a specified time. Neither the Standards of Practice nor the TREC contract forms requires a seller to remedy conditions revealed by an inspection. The decision to correct a hazard or any deficiency identified in an inspection report is left to the parties to the contract for the sale or purchase of the home.

INFORMATION INCLUDED UNDER "ADDITIONAL INFORMATION PROVIDED BY INSPECTOR", OR PROVIDED AS AN ATTACHMENT WITH THE STANDARD FORM, IS NOT REQUIRED BY THE COMMISSION AND MAY CONTAIN CONTRACTUAL TERMS BETWEEN THE INSPECTOR AND YOU, AS THE CLIENT. THE COMMISSION DOES NOT REGULATE CONTRACTUAL TERMS BETWEEN PARTIES. IF YOU DO NOT UNDERSTAND THE EFFECT OF ANY CONTRACTUAL TERM CONTAINED IN THIS SECTION OR ANY ATTACHMENTS, CONSULT AN ATTORNEY.

ADDITIONAL INFORMATION PROVIDED BY INSPECTOR

Note to clients: Upon downloading or printing this report from e-mail, some users have found that some of the checkmarks in the boxes are not marked; this is due to the fact that their computers may not have the correct fonts installed. Should your report lack these checkmarks or have any other flaws please contact us immediately for a faxed copy. GreenWorks recommends that only professionally licensed contractors complete any repairs listed, prior to closing. The inspection does not include any destructive testing or dismantling. It is possible that in the process of repair, items may be discovered that were not apparent to the inspector at the original time of inspection. Inspectors cannot be held liable for such hidden defects by the client(s). This report is prepared exclusively for the above named Client(s). It cannot be transferred to or used by any other parties in any form. Client(s) gives permission for the Inspector to discuss report findings with real estate agents, lenders, specialists, or repair persons for the sake of clarification. Additional pages may be attached to this report. Read them very carefully. This report may not be complete without the attachments. Comments may be provided by the inspector whether or not an item is deemed in need of repair. Additional information may be obtained at our website: www.GreenWorksInspections.com

NOTE: Pictures are a representative sample, and do not display every defect.

INFORMATION INCLUDED UNDER "ADDITIONAL INFORMATION PROVIDED BY INSPECTOR", OR PROVIDED AS AN ATTACHMENT WITH THE STANDARD FORM, IS NOT REQUIRED BY THE COMMISSION AND MAY CONTAIN CONTRACTUAL TERMS BETWEEN THE INSPECTOR AND YOU, AS THE CLIENT. THE COMMISSION DOES NOT REGULATE CONTRACTUAL TERMS BETWEEN PARTIES. IF YOU DO NOT UNDERSTAND THE EFFECT OF ANY CONTRACTUAL TERM CONTAINED IN THIS SECTION OR ANY ATTACHMENTS, CONSULT AN ATTORNEY.

I=Inspected

NI=Not Inspected

NP=Not Present

D=Deficient

I NI NP D

TITLE PAGES

- Additional Info Provided By Inspector**
- Inspection Scope:* Full (All Utilities Were Turned On)
- Occupancy:* Staged (Viewing Restricted)
- Structure Type:* House
- Parties Present:* Buyer, Buyers Agent
- Additional Documents Provided:* N/A
- Weather Conditions:* Sunny
- Additional Written Information Provided:* Yes
- Remodeled?:* Yes
- New Const?:* No
- Additions?:* Yes
- Property Faces:* East
- Arrival Temperature (Approximate):* 50's
- Departure Temperature (Approximate):* 60's

I=Inspected

NI=Not Inspected

NP=Not Present

D=Deficient

I NI NP D

I. STRUCTURAL SYSTEMS

A. Foundation

Comments:

Foundation Type: Pier & Beam - Crawlspace

Foundation Visibility: Partly Visible, Under Home - Partially Visible

Foundation Performance Opinion:

Performing - At this time, the foundation appears to be supporting the structure and immediate significant repair needs are not evident. Seasonal expansion and contraction observed which is considered normal for age, location and soil conditions. No major movement noted at the time of inspection.

Foundation levels - Monitor:

Based on the elevation survey taken at the time of inspection there were areas of the home that had a higher or lower elevation than the rest of the home. These areas should be monitored for continued movement. If you have any concerns about the foundation life expectancy, insurability, or the potential for future problems, a professional engineer should be consulted.

Elevation Map:

Disclaimer: The attached elevations are used for information purposes only and should not be used for serious negotiations. GreenWorks inspectors are not qualified professional engineers and are not attempting to imitate one. If you have any concerns about the foundation life expectancy, insurability, or the potential for future problems, a professional engineer should be consulted.

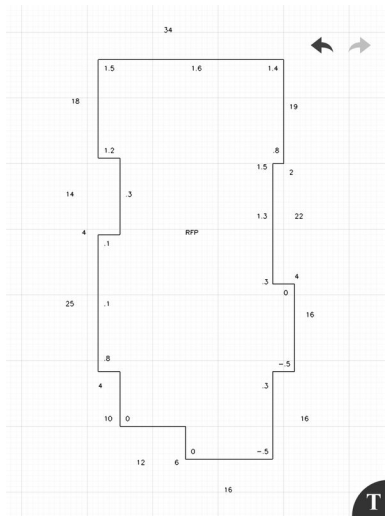

Crawlspace Photos:

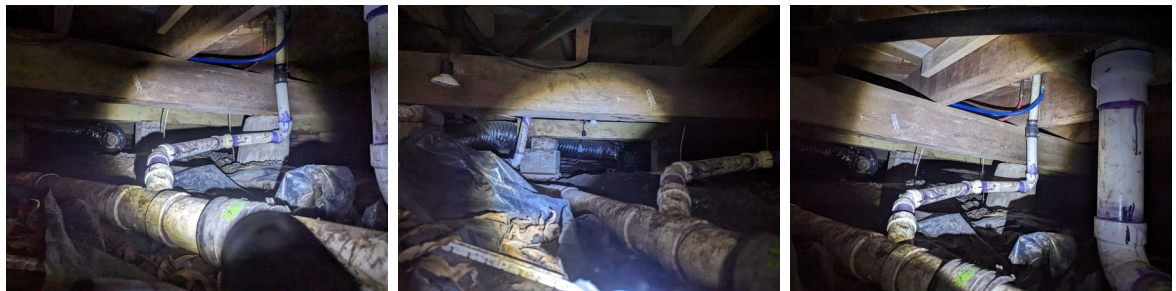

I=Inspected

NI=Not Inspected

NP=Not Present

D=Deficient

I NI NP D



I=Inspected NI=Not Inspected NP=Not Present D=Deficient

I NI NP D



Additional Comments:

Some trees may remove a few hundred gallons of water in a single day through transpiration and if they are allowed to grow too close to the structure could cause foundation problems.

Soil movement, settlement, or upheaval is directly transmitted to the foundation. It is not unusual to see a foundation in this region move in response to moisture various that normally attend seasonal changes.

Settlement of a foundation that is seasonal related usually occurs during the hot and dry summer months when the soil can sometimes dry out to a depth of more than ten feet. This drying or desiccation occurs from soil surface evaporation and transpiration of water from vegetation. Large bushes such as Red Tip Photinias and River-bottom trees consume a lot of water and should not be planted near a foundation. Heaving of a foundation that is seasonally related usually occurs during the colder and wetter months. Usually the winter months are wetter, so soils in our area tend to swell and raise the foundation. Differential foundation movement is normally the result of variations in the moisture content of the soil such as: non-uniform watering of vegetation, poor drainage way from the foundation, or leaking plumbing lines. It is possible that portions of a foundation that have previously not moved can move sometime in the future. It should be noted that clay type soils have higher bearing capacity but are subject to more movement, while sandy type soils have lower bearing capacity but are subject to less movement.

The inspector is not a professional engineer and is giving an opinion as mandatory. If you have any concerns about the foundation life expectancy, insurability, or the potential for future problems, a professional engineer should be consulted.

Crawlspace Viewed From : Under Home, Crawlspace Entrance

Specific Limitations:

Note: Specific Limitations. The inspector is not required to:

- (A) enter a crawl space or any area where headroom is less than 18 inches or the access opening is less than 24 inches wide and 18 inches high;
- (B) provide an exhaustive list of indicators of possible adverse performance; or
- (C) inspect retaining walls not related to foundation performance.

The foundation performance opinion stated below neither in any way addresses future foundation movement or settlement, nor does it certify floors to be level. Soil in the Central Texas area is known to be unstable and unpredictable. Should you have present or future concerns regarding the foundation's condition, you are strongly advised to consult with your builder and/or a licensed Professional Structural Engineer for further evaluation

High Soil:

The high soil around the structure should be trimmed and lowered to allow observation for insect activity. This condition is also conducive to moisture issues.

I=Inspected

NI=Not Inspected

NP=Not Present

D=Deficient

I NI NP D

Crawlspace -Excessive Moisture:

Inspector was not able to fully crawl or inspect due to excessive moisture or standing water resulting in excessively muddy conditions. Inspector was unable to fully see some areas under the structure.

1: Poor Ventilation of Crawlspace Area

🔴Recommendation

The foundation appears to be poorly ventilated. Increased ventilation (introduction and movement of fresh air) is recommended. This can be accomplished by adding additional vents on opposite sides of the foundation or by installing a dehumidifier to decrease moisture. Vents should be installed no more than three feet from the corners and one square foot of ventilation for every one hundred and fifty feet of crawl space as required by the IRC.

Recommendation: Contact a foundation contractor.

2: Foundation Previous Repair - Pier and Beam

🔧Handyman/Maintenance Item

There was evidence of previous repairs under the home. Inspector cannot confirm the extent or accuracy of the repairs. A Professional Engineer should be consulted if additional information is needed.

Recommendation: Contact a qualified professional engineer

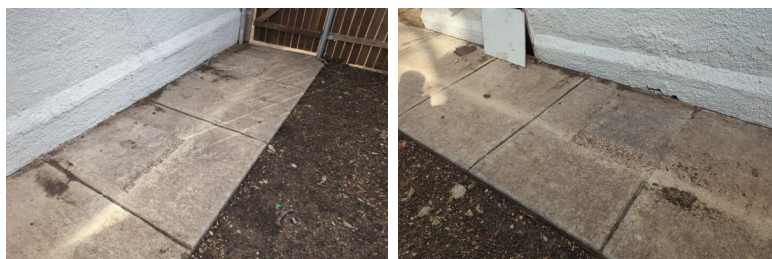

3: Crawlspace - Active water leak

🔴Recommendation

Active water leak was observed within the crawl space. Moisture penetration was confirmed with a moisture meter. Repair is recommended.

Recommendation: Contact a qualified plumbing contractor.

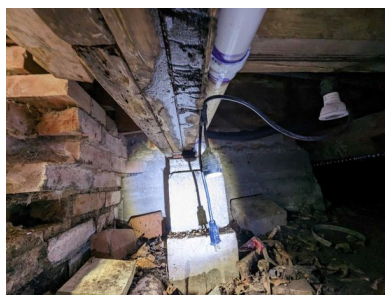

B. Grading/Drainage

Comments:

Gutters Present: No

Positive Slope on All Sides of Home: Negative on the Left Side, Negative on the Right Side

I=Inspected

NI=Not Inspected

NP=Not Present

D=Deficient

I NI NP D



Evidence of Water Penetration: No

Area Drains Present: No

Additional Information:

The strategy of a foundation is important. Expansive clay soils, which are found in this part of Texas, can be very destructive to a foundation if the moisture content of the perimeter varies. The industry standard is a grading slope of six inches within the first ten feet of a foundation. Excessive moisture forming near a structure can be destructive to a foundation. If adding soil to the perimeter to create positive drainage, remember to keep the soil level at least 4 inches from the top of the foundation. If you are able to verify that the structure is built on a clay type soil (as determined by a soil analysis testing) then that type of soil should be used to raise the soil level. Porous soils should be avoided.

Ideally finished grade, including flower bed soil, should be 4" from the top of the foundation to help prevent conducive conditions for water penetration and/or wood destroying insects.

It is recommended that all areas where expansive or collapsible soils are known to exist, a controlled method of water disposal from the roofs that will collect and discharge all roof drainage to the ground surface at least 5' from the foundation or to an approved drainage system.

Specific Limitations:

Note: Specific Limitations. The inspector is not required to:

- (A) inspect flatwork or detention/retention ponds (except as related to slope and drainage);
- (B) determine area hydrology or the presence of underground water; or
- (C) determine the efficiency or performance of underground or surface drainage systems.

During heavy rains, the accumulation of water on this lot may be unavoidable. An evaluation of soil stability is beyond the scope of this inspection. Client is advised to keep soil levels 6"-8" from top of slab and graded away to promote positive drainage and prevent water from ponding around the foundation. High soil is a conducive condition to wood destroying insects.

1: Negative Grading

🔴 Recommendation

Grading is sloping towards the home in some areas. This could lead to water intrusion and foundation issues. Recommend qualified landscaper or foundation contractor regrade so water flows away from home.

[Here is a helpful article](#) discussing negative grading.

Recommendation: Contact a qualified landscaping contractor

2: Water Ponding

🔴 Recommendation

There were areas for water ponding around the home. This may indicate improper drainage and may need repair.

Recommendation: Contact a qualified grading contractor.

I=Inspected

NI=Not Inspected

NP=Not Present

D=Deficient

I NI NP D



3: Washout

🔴 Recommendation

Washout was noted around the perimeter of the home. Repair is recommended.

Recommendation: Contact a qualified landscaping contractor



C. Roof Covering

Comments:

General Roof Photos:



I=Inspected

NI=Not Inspected

NP=Not Present

D=Deficient

I NI NP D

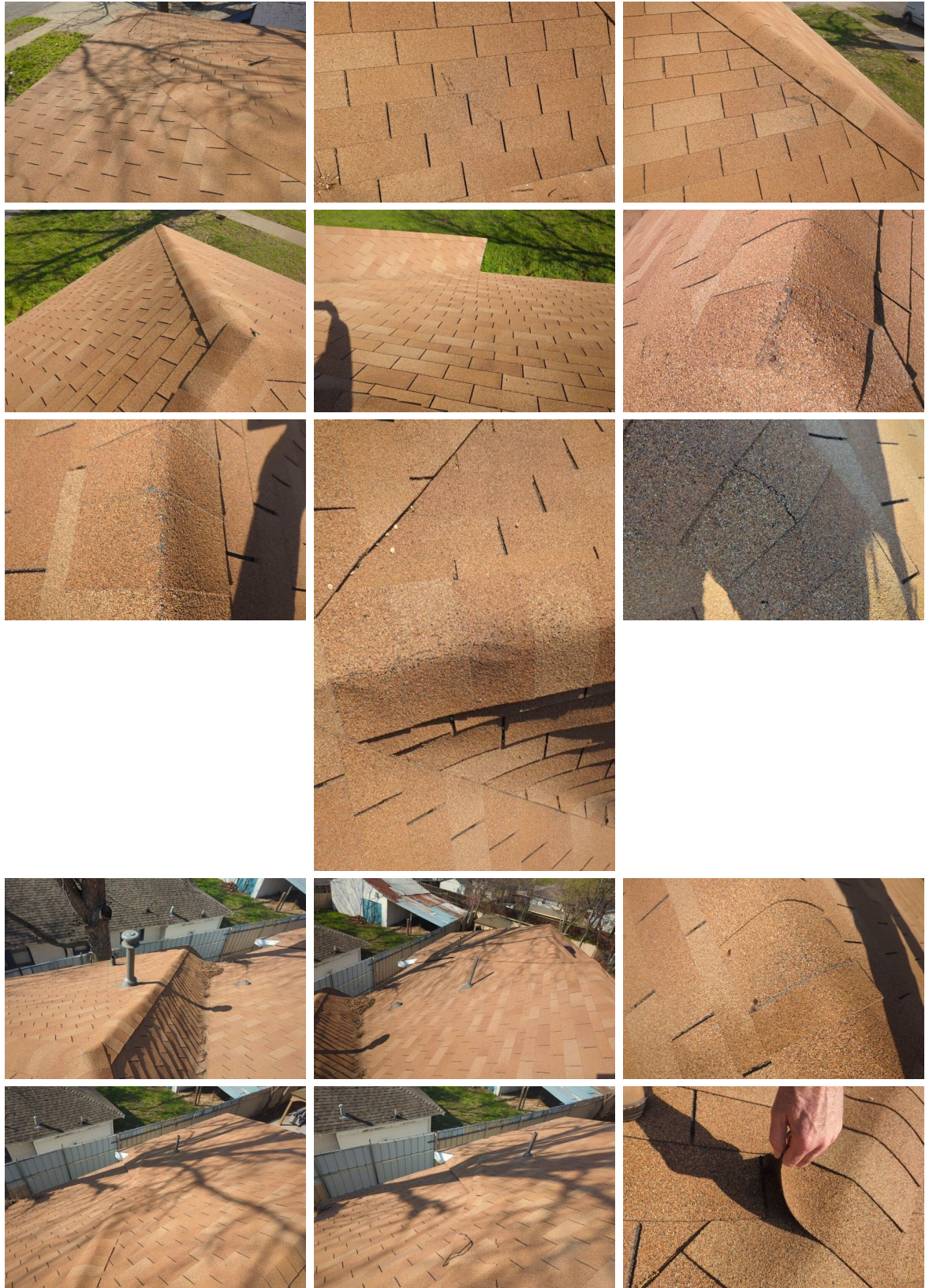

I=Inspected

NI=Not Inspected

NP=Not Present

D=Deficient

I NI NP D



Roof Viewed From: Roof, Ladder, Ground

Weather Conditions: Sunny

Roof Covering Materials: Asphalt composition

Specific Limitations:

Note: Specific Limitations. The inspector is not required to:

- (A) determine the remaining life expectancy of the roof covering;
- (B) inspect the roof from the roof level if, in the inspector's reasonable judgment, the inspector cannot safely reach or stay on the roof or significant damage to the roof covering materials may result from walking on the roof;
- (C) determine the number of layers of roof covering material;
- (D) identify latent hail damage;
- (E) exhaustively examine all fasteners and adhesion, or
- (F) provide an exhaustive list of locations of deficiencies and water penetrations.

Roof materials have a limited service life and may require spot repairs should leaks develop prior to replacement. Roof maintenance is an ongoing process and includes keeping the roof free of tree debris, replacing any loose, damaged, or missing shingles, and sealing any gaps at flashing materials. This report neither addresses future roof leaks nor does it certify the roof to be leak-free. A roofing specialist should be consulted about any concerns over roof covering life expectancy or the potential for future problems. Please note: Homeowners insurance companies use different standards and criteria for determining whether they will issue an insurance policy. These standards differ from each insurance company, as each has their own standards. Please be advised that this report does not certify nor guarantee that an insurance company will accept or reject an insurance policy based on the condition of this roof. This roof is not inspected for Insurability or Life Expectancy, and is inspected for function ONLY. As the purchaser, you may wish to have your insurance carrier inspect for insurance coverage.

General Roof:

The roofing inspection is a visual attempt to find major defects present at the time of inspection. If you have any concerns about the roof covering life expectancy, insurability or the potential for future problems, a roofing specialist should be consulted.

I=Inspected

NI=Not Inspected

NP=Not Present

D=Deficient

I NI NP D

1: Trees Close

🚩 Recommendation

There were tree limbs in close proximity to and/or touching the roof line. Trees should be trimmed to a minimum of 3 feet away from the roof. This can cause damage to the roof and prevent proper drainage. Recommend a qualified tree service trim to allow for proper drainage.

Recommendation: Contact a qualified tree service company.

2: Tree Overhang

🚩 Recommendation

Trees observed overhanging the roof. This can cause damage to the roof and prevent proper drainage. Recommend a qualified tree service trim to allow for proper drainage.

Recommendation: Contact a qualified tree service company.



3: Aggregate Loss

🚩 Recommendation

Aggregate loss was observed at the roofing material. Excessive aggregate loss can result in the prevention of the roofing material performing its intended function, which is to shed water.

Recommendation: Contact a qualified roofing professional.

4: Fasteners - Exposed

🚩 Recommendation

Exposed fasteners. Fasteners should be sealed to prevent water penetration.

Recommendation: Contact a qualified roofing professional.

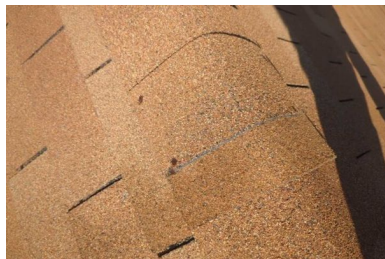

5: Gapped Flashing

🚩 Recommendation

There were gaps at the flashing material. This may allow for water penetration.

Recommendation: Contact a qualified roofing professional.

I NI NP D



6: Shingle Uplift - Lack of Bonding

 Handyman/Maintenance Item

Some of the upper shingles have not bonded sufficiently to the shingles located beneath them at the sealing strip. This could have been caused by installation of the shingles during cold weather, or that dust/dirt covered the sealing strip. These shingles should be monitored.

Recommendation: Recommend monitoring.



7: Sagging Roof

 Recommendation

There were sags or unlevel areas in the roof line. This is common and can be caused by several factors. Further evaluation is recommended, if so desired.

Recommendation: Contact a qualified professional.



I=Inspected

NI=Not Inspected

NP=Not Present

D=Deficient

I NI NP D

D. Roof Structure and Attic

Comments:

General Attic Photos:



I=Inspected

NI=Not Inspected

NP=Not Present

D=Deficient

I NI NP D



General Infrared Photos:

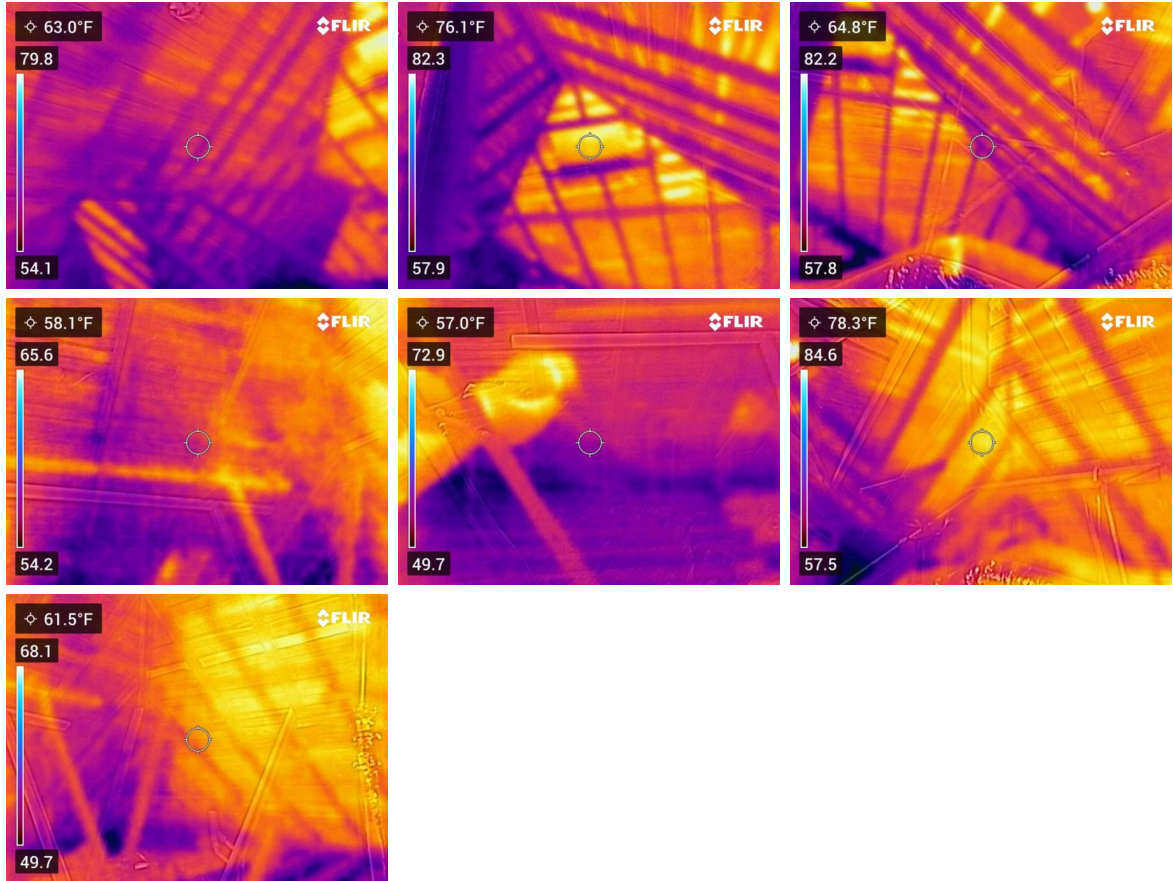

Roof Decking Type: Wood Plank, Radiant Barrier Board

Framing Type: Conventional

Ventilation Type: Soffit, Passive Vent, Wind Turbine(s)

Attic Entry Point: Interior

Attic Inspected: Yes - Walked decked Safe Areas Only

Insulation Type: Fiberglass

Insulation Amount: 0 - 6 inches - Attic Floor

Attic Temperature (Approximate °F): 61-70

Attic Humidity (Approximate %): 31-40

Specific Limitations:

Note: Specific Limitations. The inspector is not required to:

(A) enter attics or unfinished spaces where openings are less than 22 inches by 30 inches or headroom is less than 30 inches;

I=Inspected NI=Not Inspected NP=Not Present D=Deficient

I NI NP D

(B) operate powered ventilators; or
 (C) provide an exhaustive list of locations of deficiencies and water penetrations.
 The inspector cannot enter an attic with less than 5' (feet) of vertical clearance, or where he reasonably determines that conditions or materials may be unsafe. Insulation covering structural, mechanical, or electrical components may preclude inspection of these items. The inspector will report his/her attic inspection point.

Insulation improvements may be cost effective depending on the anticipated term of ownership. For your information the Department of Energy currently recommends an insulation value of R-30 to R-60 for the attic area. The R-Value is determined by the depth of the insulation, type of insulation used (bats, rolls, loose-fill, etc.) and the material the insulation is made of (fiberglass, rock wool, cellulose, etc.)

Attic:

Attic Space is Limited. Viewed from Accessible Areas Only. Insulation is not lifted, moved, or disturbed to observe for hidden defects or concerns.

Attic Missing Walkboards:

Attic lacked walking boards, so a complete inspection of the attic was not possible.

Attic - Safe Walkboards Only:

Attic observed from safe walk boards only. Entered attic and performed an incomplete limited visual inspection due to obstructions and inaccessible areas.

1: Insulation - Missing in Attic

Recommendation

There were areas of missing insulation in the attic area. The Department of Energy currently recommends an insulation value of R-30 to R-49 for the attic area.

Recommendation: Contact a qualified insulation contractor.

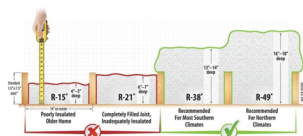

2: Low insulation

Recommendation

There were areas of low insulation. The Department of Energy currently recommends an insulation value of R-30 to R-49 for the attic area.

Recommendation: Contact a qualified insulation contractor.

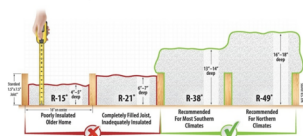

I NI NP D

3: Previous Repair

🔧 Handyman/Maintenance Item

There was evidence of previous repairs. Inspector cannot confirm the extent or quality of the repairs. A Professional Engineer should be consulted for further information.

Recommendation: Contact a qualified professional.

4: Insufficient number of missing collar ties - Current Standards

🔴 Recommendation

Insufficient number of collar ties. Collar ties help prevent rafters from pulling away from the ridge board as well as to resist rafter sag. Current code recommends collar ties at every set of rafters.

Recommendation: Contact a qualified professional.

5: Older Style Construction Methods

🔴 Recommendation

Older structures typically do not have modern standard lateral, vertical or required dimensional lumber as would be found in newer houses. This can include undersized ridge beams, lack of purlin and/or king post supports (vertical). This structure does exhibit some of these older style construction. Though there did not appear to be any noticeable deflection or differential settling, consider having a professional contractor or engineer evaluate for additional support and/or bracing recommendations.

Recommendation: Contact a qualified professional.

6: Open penetrations

🔴 Recommendation

Recommendation: Contact a qualified professional.

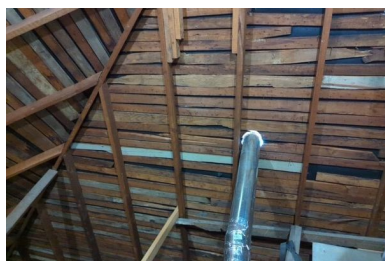

7: Insufficient roof decking

🔴 Recommendation

There were areas void of any structural r

Recommendation: Contact a qualified professional.



I=Inspected

NI=Not Inspected

NP=Not Present

D=Deficient

I NI NP D

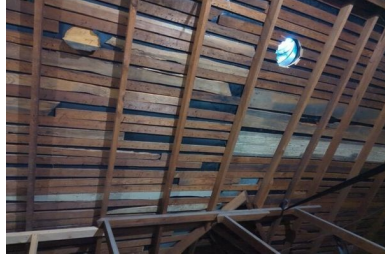

E. Walls (Interior and Exterior)
Comments:

Exterior

Front Exterior Photos:



Rear Exterior Photos:

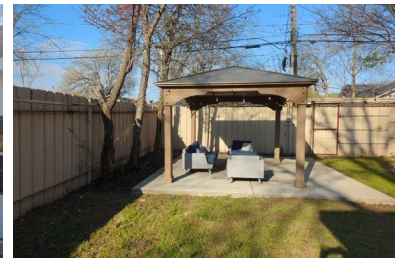

Left Exterior Photos:

I=Inspected

NI=Not Inspected

NP=Not Present

D=Deficient

I NI NP D



Right Exterior Photos:



Exterior Wall Cladding Type: Stucco/ Stucco Like, Concrete, Hardie Plank

Specific Limitations:

Note: Specific Limitations. The inspector is not required to:

(A) report cosmetic damage or the condition of floor, wall, or ceiling coverings; paints, stains, or other surface coatings; cabinets; or countertops,

(B) provide an exhaustive list of locations of deficiencies and water penetrations, (C) report the condition of awnings, blinds, shutters, security devices, or other non-structural systems; or

(D) determine the cosmetic condition of paints, stains, or other surface coatings.

The inspector cannot determine the condition of wood or structural components hidden within wall cavities.

I NI NP D

No opinion as to the condition of the wood, structural members, vapor barriers, insulation, or other components in hidden areas is implied or intended by this report.

Recently Painted - Exterior:

Some of the exterior walls and trim appear to have been recently painted. This may hide some stains, mildew, or other damage that may exist.

Previous Repairs Noted:

There were repaired cracks and separations present at the exterior wall. Repairs cannot be verified for proper installation and any hidden areas were not visible and may contain further damage.



1: Separation - Exterior Trim

🔴 Recommendation

Areas of trim were separating and lacked proper caulking. These areas are for conducive for water penetration into the home.

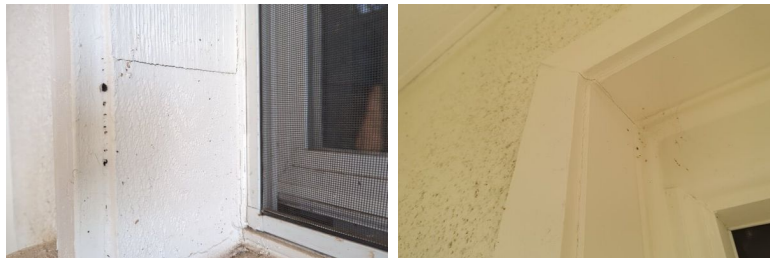

2: Chipped/Missing Paint

🔴 Recommendation

Chipped and missing paint observed at exterior walls. There were areas of discoloration.

Recommendation: Contact a qualified painting contractor.



3: Soffit - Gaps and/or Holes

🔴 Recommendation

There were gaps and/or holes present at the exterior soffit boards. These could allow pest entry. Sealing is recommended.

I NI NP D

Recommendation: Contact a handyman or DIY project



4: Trim/Siding Gaps

🔴 Recommendation

There were gaps at the exterior surfaces. These areas can allow water penetration into the structure. It is recommended these areas be sealed.

Recommendation: Contact a qualified professional.

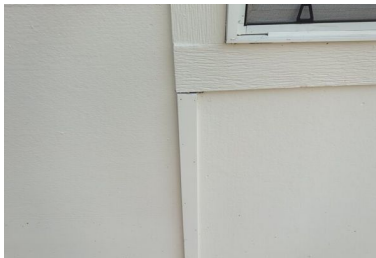

5: Veneer damage

🔴 Recommendation

Various areas of cracking and damage noted to the exterior veneer materials. Repair is recommended.

Recommendation: Contact a qualified professional.

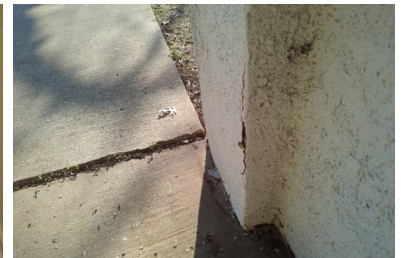

I=Inspected

NI=Not Inspected

NP=Not Present

D=Deficient

I NI NP D



6: Unfinished Area at Exterior

🔴 Recommendation

Unfinished area noted at the exterior of the home.

Recommendation: Contact a qualified professional.

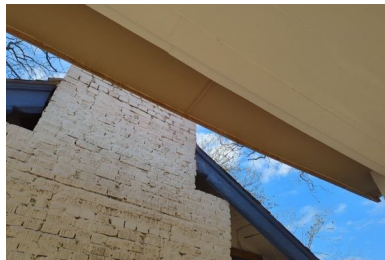

7: Missing Trim

🔴 Recommendation

Observed missing trim material. Water and/or pests can enter these areas. Repair is recommended.

Recommendation: Contact a qualified professional.

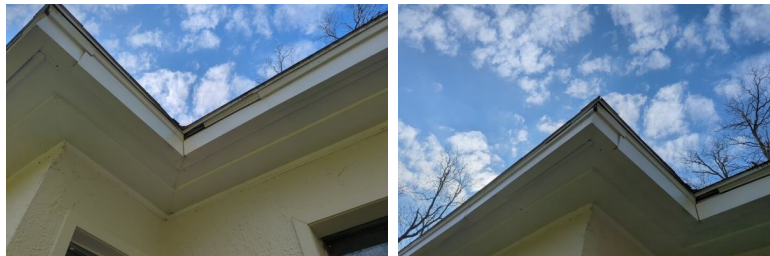

8: Displaced carport cover

🔴 Recommendation

Recommendation: Contact a qualified professional.

I=Inspected

NI=Not Inspected

NP=Not Present

D=Deficient

I NI NP D



Interior

Interior Photos:



I=Inspected

NI=Not Inspected

NP=Not Present

D=Deficient

I NI NP D



*Interior Wall Finishes: Sheet Rock
Interior Infrared Photos :*

I=Inspected

NI=Not Inspected

NP=Not Present

D=Deficient

I NI NP D

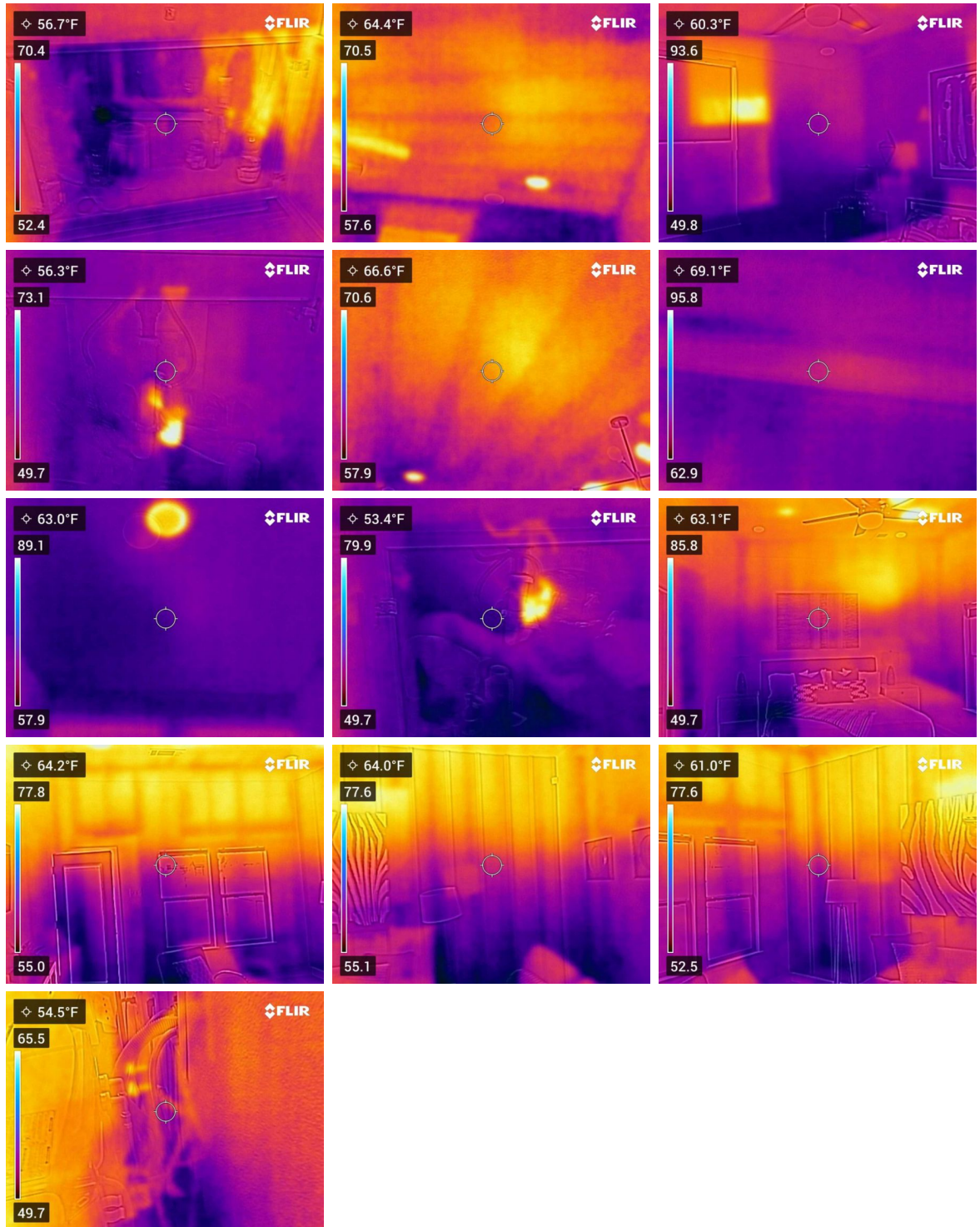

1: Interior Wall Cracks

🔴 Recommendation

Interior wall cracks were observed at the time of inspection.

Recommendation: Contact a qualified drywall contractor.

I=Inspected

NI=Not Inspected

NP=Not Present

D=Deficient

I NI NP D



Hall

2: Escutcheon Plates - Seal at Plumbing Fixtures

🔴Recommendation

The escutcheon plate and/or plumbing fixtures need to be sealed at the wall connection to prevent water from entering the wall when the water is on.

Recommendation: Contact a qualified professional.

3: Joint Separation

🔧Handyman/Maintenance Item

There are joint separations in various areas.

Recommendation: Contact a qualified drywall contractor.

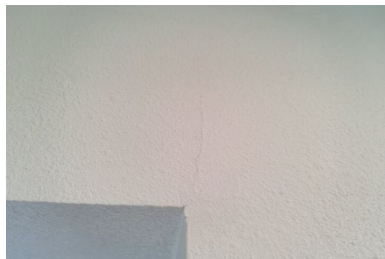

Kitchen

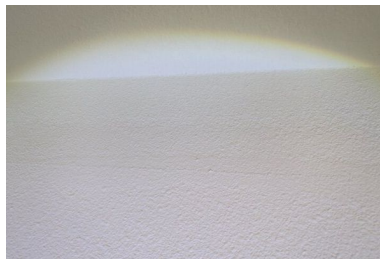

Kitchen

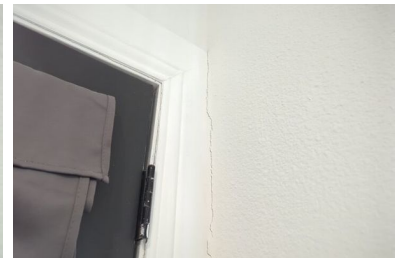
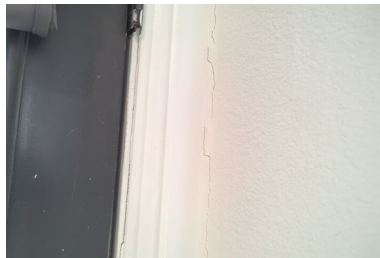

4: Tape Pulls - Ceiling/Wall

🔴Recommendation

There were tape pulls and cracks at ceiling/wall connection points.

I=Inspected

NI=Not Inspected

NP=Not Present

D=Deficient

I NI NP D

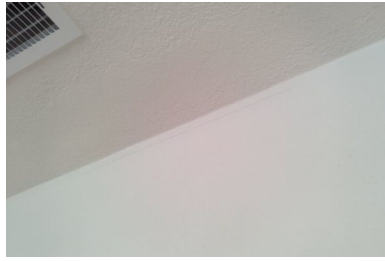

Living Room

5: Wall Damage

🔴 Recommendation

There was damage to the walls within the home. Repair is recommended.

Recommendation: Contact a qualified general contractor.



6: Bowing or Bulging Wall

🔴 Recommendation

Areas of bowing or bulging were observed at the wall.

Recommendation: Contact a qualified professional.

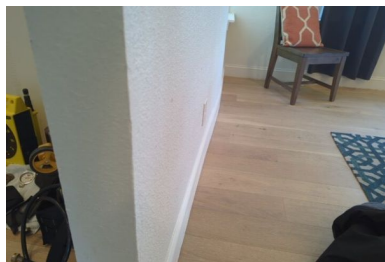

Dining Room

7: Crushing Joint

🔴 Recommendation

There was a crushing joint at the wall. These are caused by compression of the materials from the weight above. They are not necessarily a sign of structural issues.

Recommendation: Contact a qualified drywall contractor.

I=Inspected

NI=Not Inspected

NP=Not Present

D=Deficient

I NI NP D



8: Trim Separation/Gapping

Handyman/Maintenance Item

Trim separation was observed at areas of the interior trim materials.

Recommendation: Contact a qualified professional.

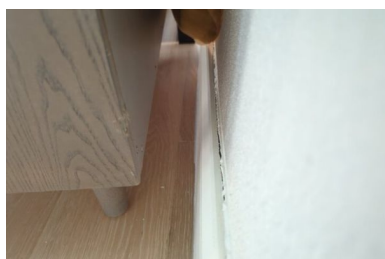

Bedroom 2

F. Ceilings and Floors

Comments:

Ceilings

Specific Limitations:

Note: Specific Limitations. The inspector is not required to:

(A) report cosmetic damage or the condition of floor, wall, or ceiling coverings; paints, stains, or other surface coatings; cabinets; or countertops,

(B) provide an exhaustive list of locations of deficiencies and water penetrations; or

(C) determine the cosmetic condition of paints, stains, or other surface coatings.

The inspector cannot determine the condition of structural components in hidden ceiling or floor cavities. No opinion as to the condition of the wood, structural members, or other components in hidden areas is implied or intended by this report.

1: Ceiling Cracks

Recommendation

Cracks in the ceilings were observed at the time of inspection.

Recommendation: Contact a qualified professional.

I=Inspected NI=Not Inspected NP=Not Present D=Deficient

I NI NP D



Guest bath

2: Joint Separation

Handyman/Maintenance Item

There is joint separation in various areas.

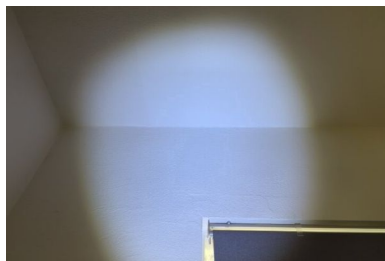

Bedroom 1

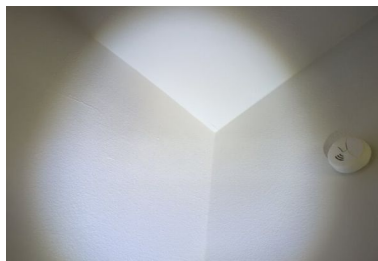

Bedroom 1

Floors

Specific Limitations:

Note: Specific Limitations. The inspector is not required to:

(A) report cosmetic damage or the condition of floor, wall, or ceiling coverings; paints, stains, or other surface coatings; cabinets; or countertops,

(B) provide an exhaustive list of locations of deficiencies and water penetrations; or

(C) determine the cosmetic condition of paints, stains, or other surface coatings.

The inspector cannot determine the condition of structural components in hidden ceiling or floor cavities. No opinion as to the condition of the wood, structural members, or other components in hidden areas is implied or intended by this report.

Floors - Covered:

There are large area rugs on the flooring in most rooms, these areas were not inspected due to these rugs.

1: Floor/Wall Separation

Recommendation

Throughout home

The floor was separated and gapped at the wall connection point.

Recommendation: Contact a qualified professional.

I=Inspected

NI=Not Inspected

NP=Not Present

D=Deficient

I NI NP D



2: Creaking Floors

🔴 Recommendation

Creaky floors were noted in various areas.

Recommendation: Contact a qualified flooring contractor

G. Doors (Interior and Exterior)

Comments:

Entry Door Type: Wood/Fiberglass w/glass

Overhead Garage Door Type: N/A

Specific Limitations:

Note: Specific Limitations. The inspector is not required to:

- (A) report the condition of awnings, blinds, shutters, security devices, or other non-structural systems;
 - (B) determine the cosmetic condition of paints, stains, or other surface coatings; or;
 - (C) operate a lock if the key is not available,
 - (D) provide an exhaustive list of locations of deficiencies and water penetrations.
- The inspector cannot determine the condition of wood or structural components hidden within wall cavities. No opinion as to the condition of the wood, structural members, vapor barriers, insulation, or other components in hidden areas is implied or intended by this report. We do NOT inspect for Safety Glass or Storm Doors.

1: Door Frame Separation

🔴 Recommendation

Observed door frame separation at the home.

Recommendation: Contact a qualified professional.

I=Inspected

NI=Not Inspected

NP=Not Present

D=Deficient

I NI NP D



Bedroom 2

2: Out of Square

🔴 Recommendation

Some doors are out of square.

Recommendation: Contact a qualified door repair/installation contractor.



3: Not Latching

🔴 Recommendation

There were doors present that did not latch when shut.

Recommendation: Contact a qualified door repair/installation contractor.

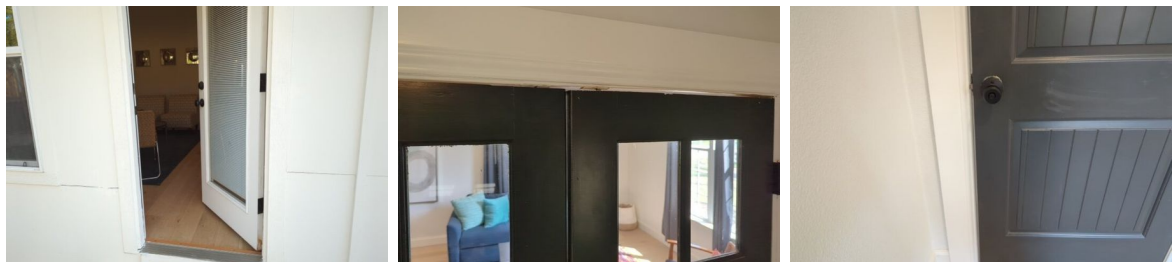

Patio

Bedroom 2

4: Shower Door Collides

🔧 Handyman/Maintenance Item

The shower door collides with another surface in the bathroom. Risk for damage is high and adjustment or stopper installation is recommended.

Recommendation: Contact a handyman or DIY project

I=Inspected

NI=Not Inspected

NP=Not Present

D=Deficient

I NI NP D

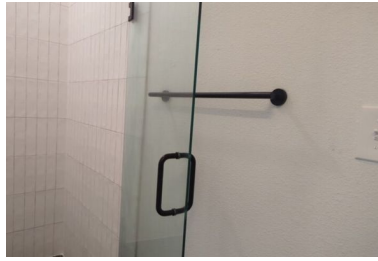

Master

5: Door Frame Damage

🔴 Recommendation

The door frame is damaged. Repair is recommended.

Recommendation: Contact a qualified door repair/installation contractor.



Patio

6: Door out of plumb

🔴 Recommendation

Recommendation: Contact a qualified professional.



Master

H. Windows

I=Inspected

NI=Not Inspected

NP=Not Present

D=Deficient

I NI NP D

Comments:

Window Type: Vinyl - Double pane insulated, Metal - Double pane insulated

Specific Limitations:

Note: Specific Limitations. The inspector is not required to:

(A) exhaustively inspect insulated windows for evidence of broken seals;

(B) exhaustively inspect glazing for identifying labels; or

(C) identify specific locations of damage.

The inspector does not inspect or comment on the presence or condition of storm windows, awnings, shutters, or other security devices or systems. Failed thermal seals in insulated windows are not always detectable, depending upon atmospheric conditions or if they are particularly dirty or otherwise obstructed.

Visible signs of voided (lost thermal seal) insulated windows can fluctuate with changes in lighting, temperature and/or humidity. Only obvious seal failure (window fogging) is noted in this report. Windows can be constructed with multiple sashes and/or lites which could increase the number of actual voided glazed panels. Should this be a concern, our client should contact a glass window specialist to determine if any additional windows have broken seals. The inspector does not remove any screens or inspect windows which would require a ladder to inspect

Thermal Pane Windows:

As THERMAL PANE WINDOWS lose their vacuum, moisture may appear, and then disappear, depending on inside and outside temperature, barometric pressure and the relative humidity. Windows are listed as OBSERVED AT THE TIME OF THE INSPECTION ONLY, and NO WARRANTY IS EXPRESSED OR IMPLIED. If voided or damaged thermal panes are noted on the inspection report, we would strongly urge that a qualified glass company or glazier be contacted for a further evaluation and any estimates that might be needed.

1: Caulking - Interior Separation

[Handyman/Maintenance Item](#)

The interior caulk is missing, cracked, or separated around the windows in the home.

Recommendation: Contact a handyman or DIY project

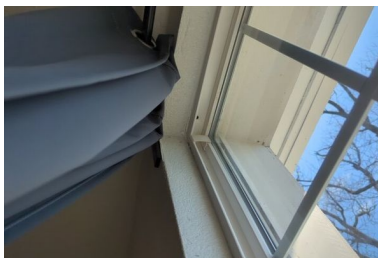

2: Missing Screens

[Handyman/Maintenance Item](#)

Window screens were not installed at some windows at the time of inspection. It is recommended that screens be installed to prevent insects from coming in if windows are left open.

I=Inspected

NI=Not Inspected

NP=Not Present

D=Deficient

I NI NP D



Bathroom

3: Hard to Open

🔴 Recommendation

Various window were hard to open and close. Adjustment or lubrication is recommended.

Recommendation: Contact a qualified window repair/installation contractor.

4: Caulking - Exterior Window Separation

🔴 Recommendation

Various areas

The caulking was separated and/or missing around some windows at the exterior.

Recommendation: Contact a handyman or DIY project

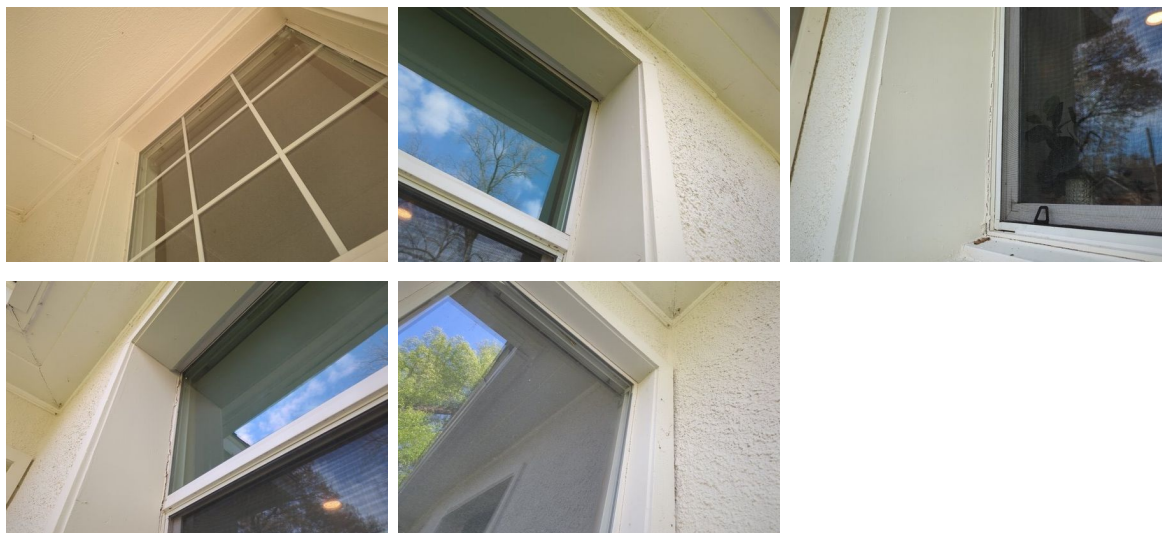

5: Hardware Loose

🔴 Recommendation

Hardware was loose at some windows in the home. This makes it difficult to operate the window in case of emergency.

Recommendation: Contact a qualified professional.

I=Inspected

NI=Not Inspected

NP=Not Present

D=Deficient

I NI NP D



Dining Room

6: Safety Glass - Tub

Recommendation

Safety glass should be present within 5 feet of the tub edge. Markings were not found.

Recommendation: Contact a qualified professional.

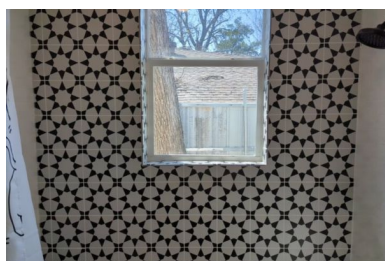

I. Stairways (Interior and Exterior)

Comments:

Specific Limitations:

Note: Specific Limitations. The inspector is not required to exhaustively measure every stairway component.

J. Fireplaces and Chimneys

Comments:

Fireplace Fuel Source: N/A

Cclamp?: N/A

Damper: N/A

Chim Flue: N/A

Firestop?: N/A

Specific Limitations:

Note: Specific Limitations. The inspector is not required to:

- (A) verify the integrity of the flue;
- (B) perform a chimney smoke test; or
- (C) determine the adequacy of the draft.

TREC Limitations. The inspector is not required to inspect or comment on chimney structures located more than 8' (feet) above roofline. Freestanding wood burning stoves are beyond the scope of this inspection

K. Porches, Balconies, Decks, and Carports

Comments:

General Photos:

I=Inspected

NI=Not Inspected

NP=Not Present

D=Deficient

I NI NP D



Specific Limitations:

Note: Specific Limitations. The inspector is not required to:

- (A) exhaustively measure every porch, balcony, deck, or attached carport components; or
- (B) enter any area where headroom is less than 18 inches or the access opening is less than 24 inches wide and 18 inches high.

1: Patio/Porch Cracking

[Handyman/Maintenance Item](#)

There is cracking noted at the patio/porch surfaces.

II. ELECTRICAL SYSTEMS

A. Service Entrance and Panels

Comments:

General Electrical Photos:

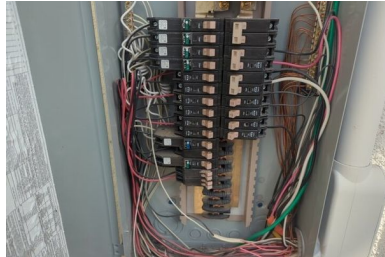
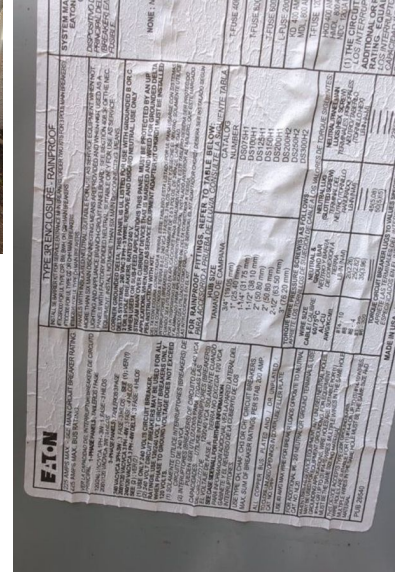

Electrical Service Entrance: Underground

Panel Location : Exterior

Panel Brand: Eaton

Main Conductor Wiring Type: Copper

Panel Labeled?: Partially

Panel Amps: 150 Amps

Over-Current Protection: Breakers

Sub-panel Location : Hallway, Panel not live

Grounding Types: Main Panel, Grounding Rod

Surge Protective Device Not Present:

Current electrical standards require service panels on dwelling units to have Surge Protective Devices (SPD) installed. These devices were not observed at the time of inspection. Not all local jurisdictions have adopted this new code and these may not have been a part of the building standards at the time construction began. If concerns exist, it is recommended to consult builder representative, licensed electrician, or local authority having jurisdiction.

Specific Limitations:

Note: Specific Limitations. The inspector is not required to:

(A) determine present or future sufficiency of service capacity amperage, voltage, or the capacity of the

I=Inspected NI=Not Inspected NP=Not Present D=Deficient

I NI NP D

electrical system;

(B) test arc-fault circuit interrupter devices when the property is occupied or damage to personal property may result, in the inspector's reasonable judgment;

(C) conduct voltage drop calculations;

(D) determine the accuracy of overcurrent device labeling;

(E) remove covers where hazardous as judged by the inspector;

(F) verify the effectiveness of overcurrent devices; or

(G) operate overcurrent devices.

The inspector is not required to determine the insurability of the property. The inspector will inspect the service entrance cables and report any deficiencies in the insulation, drip loop, service line clearances and separation of conductors at weather heads.

1: White Wires Used Without Black Tape

 Handyman/Maintenance Item

The panel had neutral (white) wires being used as hot (black) wires and were not taped to indicate the same.

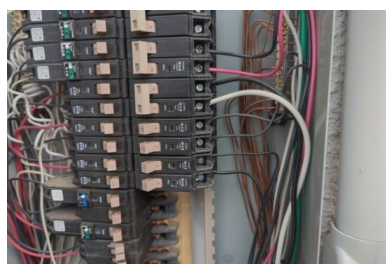

2: Missing Gas Ground Bond

 Recommendation

There is no ground bond on the gas supply line, as required by current standards.

Recommendation: Contact a qualified electrical contractor.

B. Branch Circuits, Connected Devices, and Fixtures

Comments:

Wiring Type: Copper

Smoke Detectors Present: Living Room, Not Observed at all required areas

Smoke Detectors Hard Wired: No

Carbon Monoxide Detectors: No - (If gas appliances are present

GFCI - Bathrooms: Present and Tripping, Not all bathrooms have outlets

GFCI - Kitchen: Present and Tripping

GFCI - Exterior: Present and Tripping

GFCI - Garage: N/A

GFCI - Laundry: Present and Tripping

GFCI - Detached Structure: N/A

GFCI - Bar Area: N/A

Dryer Outlet Tested: Yes

Additional 240V Outlet Tested: N/A

Specific Limitations:

Note: Specific Limitations. The inspector is not required to:

(A) inspect low voltage wiring;

(B) disassemble mechanical appliances;

(C) verify the effectiveness of smoke alarms;

I=Inspected

NI=Not Inspected

NP=Not Present

D=Deficient

I NI NP D

- (D) verify interconnectivity of smoke alarms;
- (E) activate smoke or carbon monoxide alarms that are or may be monitored or require the use of codes;
- (F) verify that smoke alarms are suitable for the hearing-impaired;
- (G) remove the covers of junction, fixture, receptacle or switch boxes unless specifically required by these standards

The inspector will report as in need of repair the lack of ground fault circuit protection where required.
 **Homes built prior to 1974 could have aluminum wiring present in the branch circuits. Inspector observes branch circuit wiring type within the service panel. Hidden wiring that is not present within the panel could not be observed by inspector.

Not Able To Inspect Outlets - Home Occupied: The outlets that are behind or under furniture, stored items or plugged into electronics were not tested.

1: Loose Outlets and Switches

🔴Recommendation

Various loose outlets/switches observed in the home. Tightening of these receptacles is recommended to prevent any loose wiring or electrical shock from occurring.

Recommendation: Contact a qualified electrical contractor.

2: Open Ground Outlet Readings

🔴Recommendation

Hand held tester showed open ground readings at one or more outlets. This can be a risk of shock to people or damage to equipment, notably electronics and appliances, that are plugged into the outlet. Repair is recommended.

Recommendation: Contact a qualified electrical contractor.



Dining Room



Bedroom 2



3: Not Grounded - 3-Prong

🔴Recommendation

When 2 prong outlets are changed to a 3-prong outlet, this represents the outlet as grounded, without actually being grounded. Many of the outlets in the home appear to have this condition.

Recommendation: Contact a qualified electrical contractor.

4: Missing Smoke Alarms

🔴Recommendation

Insufficient number of smoke alarms. Current TREC standards require smoke alarms to be present in all bedrooms, all hallways adjacent to the bedrooms, and living rooms. Some city jurisdictions require smoke alarms to be present in the bedroom and hallways adjacent to. It is recommended the local building codes be checked for proper installation.

I=Inspected

NI=Not Inspected

NP=Not Present

D=Deficient

I	NI	NP	D
---	----	----	---

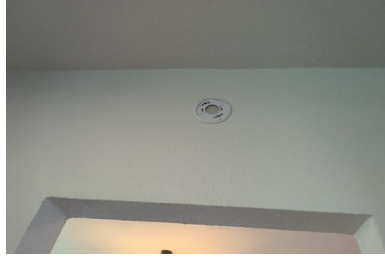

Kitchen

5: No Outlet Within 3' of Sink

🔴 Recommendation

Current standards require an electrical outlet to be present within 3 feet of the sink.

Recommendation: Contact a qualified electrical contractor.

-

C. Other

Comments:

III. HEATING, VENTILATION AND AIR CONDITIONING SYSTEMS

A. Heating Equipment

Comments:

Unit Information:

The National Association of Home Builders and Bank of America Home Equity division produced a Study of Life Expectancy of Home Components in February 2007. Life expectancy is based on first owner use.

That study noted that the expected life span (on average) of gas-fired heaters is about 18 years.

That study noted that the expected life span (on average) of electric heaters is about 15-20 years.

Take this into consideration when noting the manufacture date for the unit at this property. It is recommended that units of the above ages be further evaluated and cleaned to verify that the heat exchanger and/or heating elements are working properly.



Furnace Energy Source: Gas

Furnace Type: Forced Air - Gas Fired

Furnace Location: Attic

Heating Temperatures:

Return	67-79
Kitchen	115
Living Room	125
Dining Room	118
Master Bedroom	121
Bedroom 1	118
Bedroom 2	121

I=Inspected NI=Not Inspected NP=Not Present D=Deficient

I NI NP D

Bedroom 3 124

Family Room 115

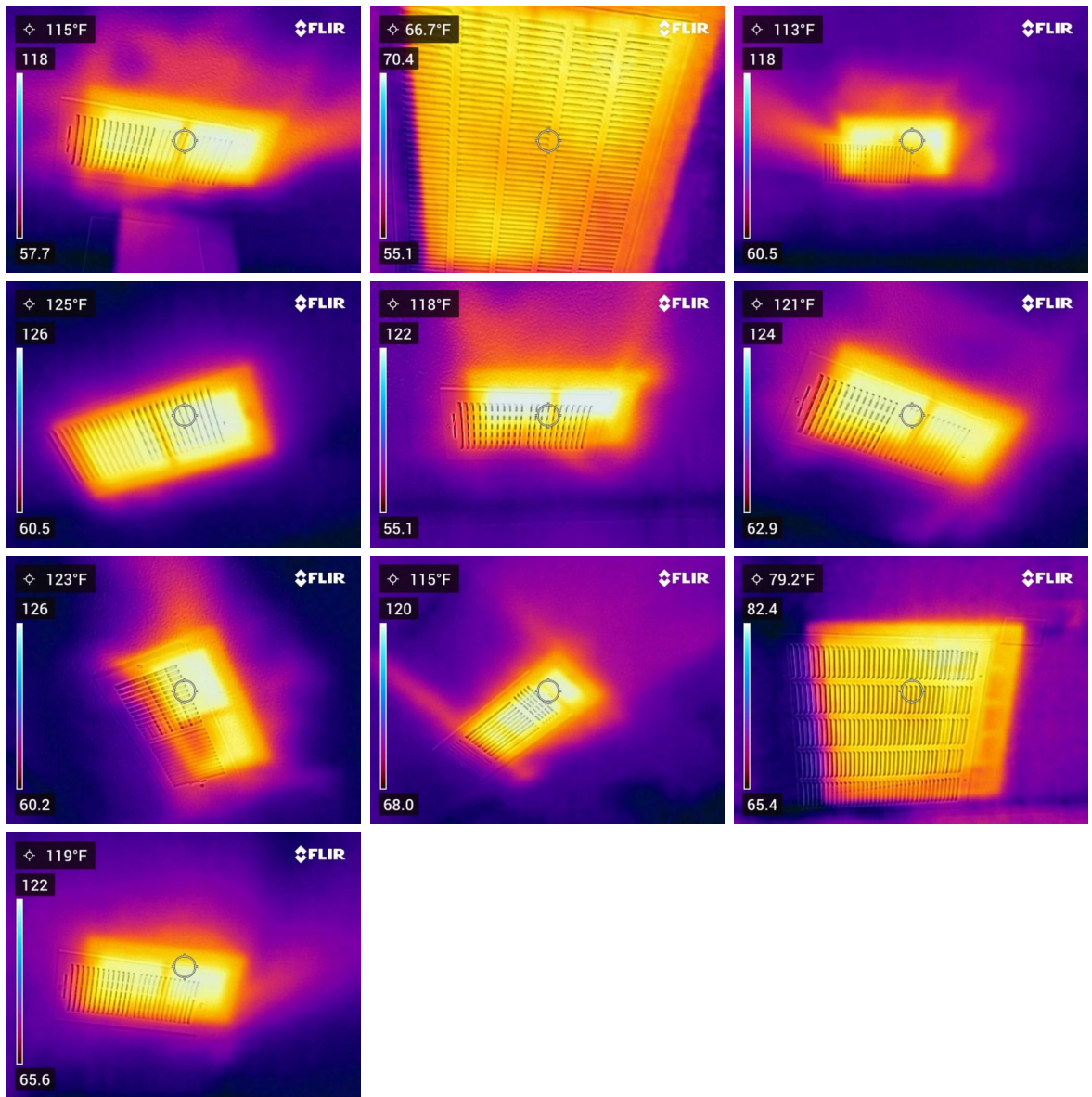

Specific Limitations:

Note: Specific Limitations

The system fan, burner, and heat exchanger are not readily available for inspection without disassembly of the unit. Because we do not disassemble equipment, the condition of the system interior is unknown. If the system does not have a documented history of regular cleaning and maintenance, servicing by a licensed HVAC technician will be required. Recommend annual cleaning and service by licensed HVAC technician.

I=Inspected NI=Not Inspected NP=Not Present D=Deficient

I NI NP D

The inspector will describe the type of heating system and its energy sources and inspect each unit.
*Manufacturer numbers are provided as additional information to the client. Appliances are not researched for recalls. If buyer has further concerns regarding recalls the appliance manufacturer should be contacted.

Heat Exchanger:

Determining the full integrity of the heat exchanger requires requires the dismantling of the heat exchanger and is beyond the scope of a visual inspection, as outlined in Title 535.229 (t) of the Standards and Practices. Due to design, heat exchangers are viewed from the draft hood and / or burner opening only and are not fully inspected. We strongly urge you to have an industry accepted specialist fully inspect and report on the internal condition of the heat exchanger.

Attic Access:

Unit (s) were located in the attic and proper clearances and walk boards were NOT present in front of the equipment; it is recommended that a proper platform and safe walk boards be added to prevent injury.

1: No drip leg/Sediment Trap

🚫 Recommendation

A drip leg or sediment trap was not observed on the gas line at the unit.

Recommendation: Contact a qualified professional.

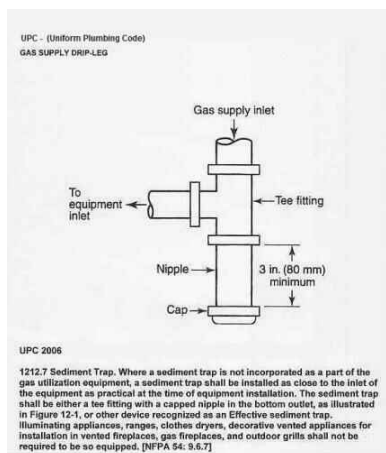

B. Cooling Equipment

Comments:

Condensing Unit Information:

The National Association of Home Builders and Bank of America Home Equity division produced a Study of Life Expectancy of Home Components in February 2007. Life expectancy is based on first owner use. That study noted that the expected life span (on average) of air conditioners is about 10-15 years. Take this into consideration when noting the manufacture date listed for the unit at this property. Any service life in excess of 15 years is in the realm of good fortune only and should be viewed as such. The complete system will require a higher level of maintenance, and may be more prone to major component breakdown. Predicting the frequency or time frame for repairs on any mechanical equipment is virtually impossible.

I=Inspected NI=Not Inspected NP=Not Present D=Deficient

I NI NP D



2021, 5ton, hfc410

Evaporative Coil Unit Information:

The National Association of Home Builders and Bank of America Home Equity division produced a Study of Life Expectancy of Home Components in February 2007. Life expectancy is based on first owner use. That study noted that the expected life span (on average) of air conditioners is about 10-15 years. Take this into consideration when noting the manufacture date listed for the unit at this property. Any service life in excess of 15 years is in the realm of good fortune only and should be viewed as such. The complete system will require a higher level of maintenance, and may be more prone to major component breakdown. Predicting the frequency or time frame for repairs on any mechanical equipment is virtually impossible.

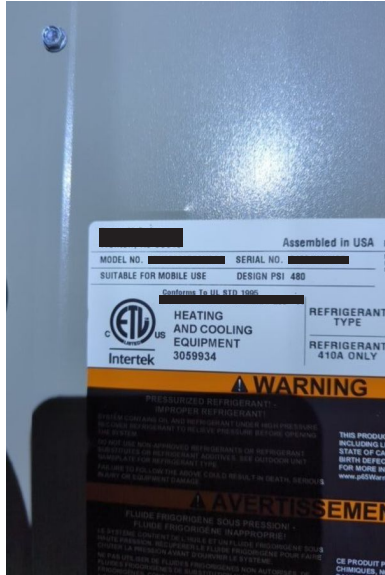

Outdoor Temp: 60s
Coolant Type: HFC - 410A
Cooling Temperatures:

Location	Return	Supply	Differential
Kitchen	47-55	23	
Living Room		32	

I=Inspected NI=Not Inspected NP=Not Present D=Deficient

I	NI	NP	D
---	----	----	---

Dining Room 30

Master Bedroom 35

Bedroom 1 34

Bedroom 2 30

Bedroom 3 30

Family Room 32

Playroom

Media Room

Office

A differential of 15 degrees Fahrenheit or higher is desired for optional efficiency.

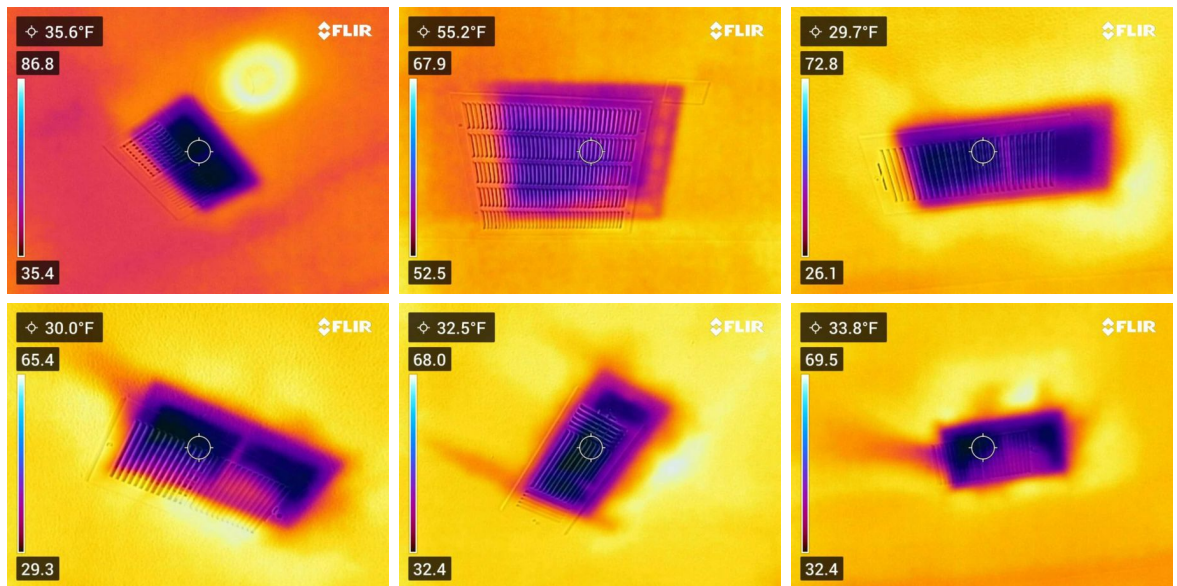

I=Inspected NI=Not Inspected NP=Not Present D=Deficient

I NI NP D

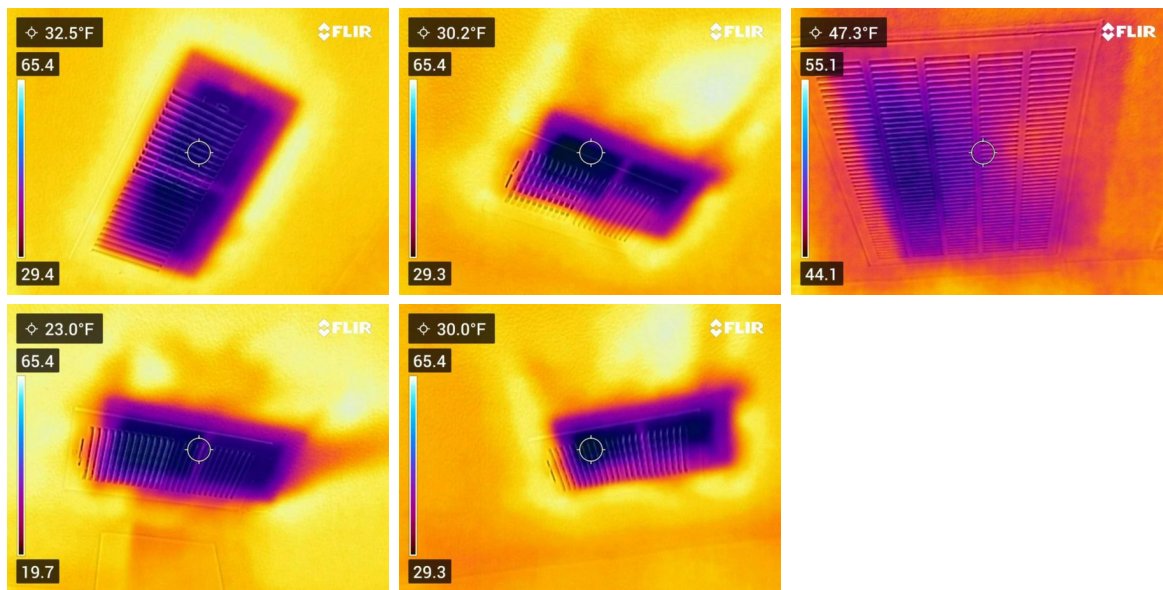

Specific Limitations:

Note: Specific Limitations. The system fan and evaporative coil are not readily accessible for inspection without disassembly of the unit. Because we do not disassemble equipment, the condition of the system interior is unknown. If the system does not have a documented history of regular cleaning and maintenance, servicing by a licensed HVAC technician is required. Recommend annual cleaning and service by licensed HVAC technician. The inspector will not pressure test the system coolant or determine the presence of leaks; or operate setback features on thermostats or controls. We do not inspect for efficiency, capacity or adequacy of units, and the secondary drain lines are not traced for termination. Secondary drain lines are not tested for proper drainage. The inspector will describe the type of cooling system and its energy sources and inspect each unit.

The inspector does not determine the Seasonal Energy Efficiency Ratio (SEER) rating of the HVAC system.

This equipment rating is published in the Air Conditioning and Refrigeration Institute ARI directory.

The inspector does not determine if an air conditioning units condensing coils and evaporating coils are "matched" according to the manufacturer's specifications. If any concerns exist about the "matching" of evaporator coils with condensing coils, a qualified HVAC technician should evaluate the complete HVAC system.

Evaporative Coil (s):

The coils of the indoor portion of the HVAC system were not actually observed and are beyond the scope of this visual inspection. The "indoor" coils are enclosed within the actual cabinet which would require specialized tools / equipment to access. The HVAC unit's warranty could be voided if an unqualified non-Licensed HVAC technician were to cut into the plenum, damage sealant, remove support strapping mounted in the evaporator coil's access panel, remove flues and/or remove any of the ductwork. If documentation is unavailable on the maintenance history of the units or if any concerns exist about the condition of the coils, a qualified licensed HVAC technician should evaluate the complete HVAC system.

Limited access to air handler:

1: Refrigerant Line Insulation

🔴 Recommendation

Insulation is damaged and separating on the large Freon suction line from the air conditioning compressor.

Recommendation: Contact a qualified heating and cooling contractor

I=Inspected

NI=Not Inspected

NP=Not Present

D=Deficient

I NI NP D



2: Uninsulated Trap

➔ Recommendation

There was an uninsulated trap at the HVAC in the attic. This can lead to water damage to ceiling, insulation and walking deck boards. It can also lead to mold growth.

Recommendation: Contact a qualified HVAC professional.

C. Duct Systems, Chases, and Vents

Comments:

General Ductwork Photos:

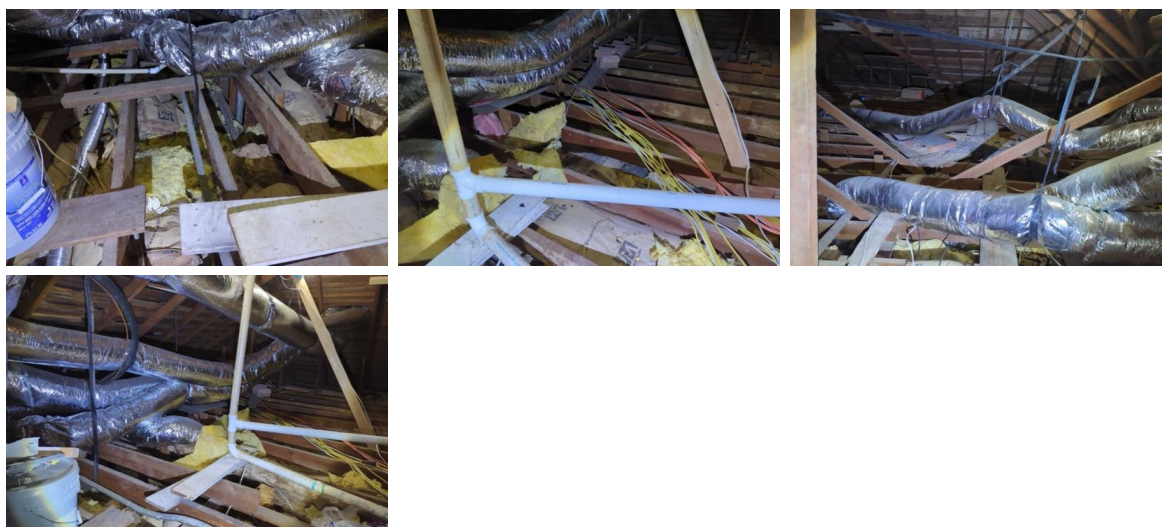

Filter Type: Disposable

Filter Location: Bedroom Ceiling, Hallway Ceiling

Filter Size: 20X20X1, 20X25X1

Duct Location: Attic, Crawl Space

Duct Type: Flexible

Specific Limitations:

Note: Specific Limitations. The inspector will not determine the efficiency, adequacy, or capacity of the systems; determine the uniformity of the supply ducts; determine the types of materials contained in insulation, wrapping of pipes and ducts, jackets, boilers, and wiring; operate venting systems unless ambient temperatures, or other circumstances, in the reasonable opinion of the inspector, are conducive to safe operation without damage to the equipment or operate a unit outside its normal operating range. Tip: Seal the plenum, duct hubs and evaporator coil seams with aluminum tape or HVAC ductwork mastic for a possible savings in energy consumption of as much as 35%.

I=Inspected

NI=Not Inspected

NP=Not Present

D=Deficient

I NI NP D

Duct Interior:

The interior of the ducting system is not accessible for observation and inspection. Ducts are tested by air temperature at the rooms and inspected visually.

Not Inspected - Limited Attic Access:

Attic access was limited and ducts were not fully visible for inspection.

Not Inspected - Limited Crawlspace Access:

Crawlspace access was limited. Ducts were not fully visible for inspection.

1: Register Not Connected

Recommendation

The register does not appear to be connected to the unit.

Recommendation: Contact a qualified professional.



Master

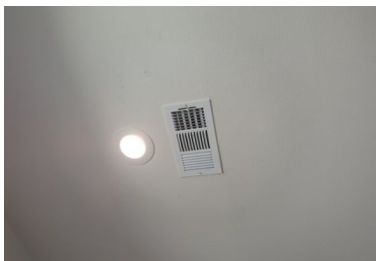

Master

-
-
-
-

D. Other

Comments:

I=Inspected

NI=Not Inspected

NP=Not Present

D=Deficient

I NI NP D

IV. PLUMBING SYSTEMS

A. Plumbing Supply, Distribution Systems and Fixtures

Comments:

General Plumbing Photos:

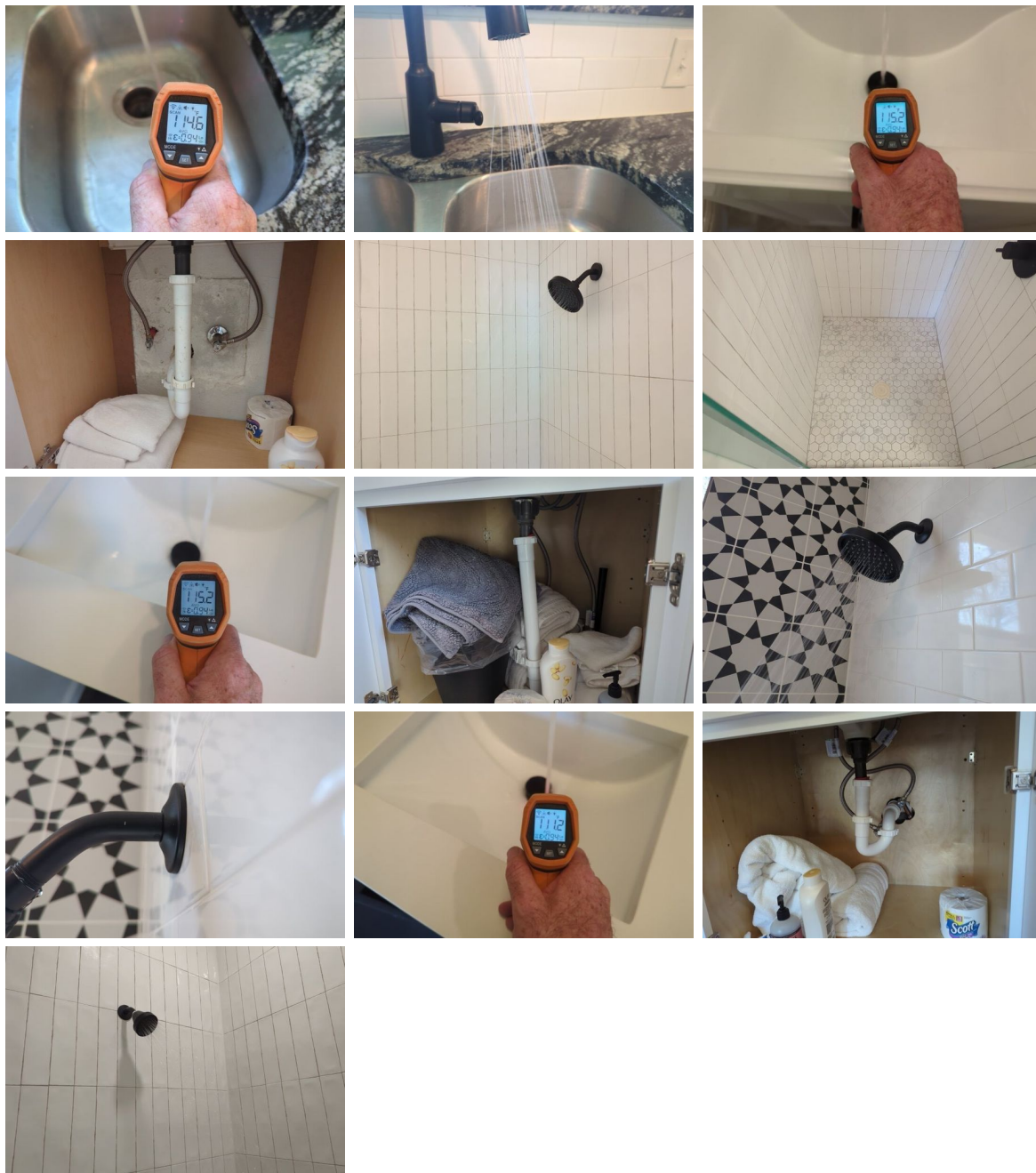

Water Meter Location: Alley
Main Water Shut off Location: Undetermined
Static Water Pressure Reading: 85
Type of Supply Piping Material Observed: Copper

I=Inspected NI=Not Inspected NP=Not Present D=Deficient

I NI NP D

Specific Limitations:

Note: Specific Limitations. The inspector is not required to:

- (A) operate any main, branch, or shut-off valves;
- (B) operate or inspect sump pumps or waste ejector pumps;
- (C) verify the performance of:
 - (i) the bathtub overflow;
 - (ii) clothes washing machine drains or hose bibs; or
 - (iii) floor drains;
- (D) inspect:
 - (i) any system that has been winterized, shut down or otherwise secured;
 - (ii) circulating pumps, free-standing appliances, solar water heating systems, water-conditioning equipment, filter systems, water mains, private water supply systems, water wells, pressure tanks, sprinkler systems, swimming pools, or fire sprinkler systems;
 - (iii) inaccessible gas supply system components for leaks;
 - (iv) for sewer clean-outs; or
 - (v) for the presence or performance of private sewage disposal systems; or
- (5) determine:
 - (A) quality, potability, or volume of the water supply; or
 - (B) effectiveness of backflow or anti-siphon devices.

Plumbing - Visible Areas:

Plumbing Areas - Only Visible Plumbing Inspected

1: Loose Exterior Fixture

🚩 Recommendation

The exterior faucet was loose at the wall connection point.

Recommendation: Contact a qualified plumbing contractor.

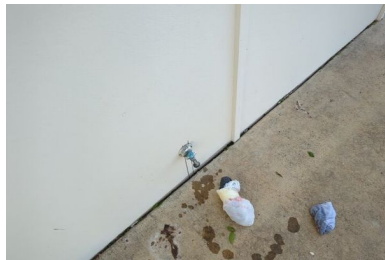

2: Anti-Siphon Exterior Fixture

🚩 Recommendation

For safety reasons, an anti-siphon valve should be added to the exterior faucets to prevent cross contamination of the water supply.

Recommendation: Contact a qualified plumbing contractor.

3: Hot and Cold Orientation - Reversed

🚩 Recommendation

The hot and cold faucets are reversed.

Recommendation: Contact a qualified plumbing contractor.

I=Inspected

NI=Not Inspected

NP=Not Present

D=Deficient

I	NI	NP	D
---	----	----	---

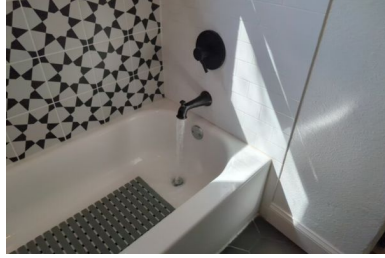

Bathroom

4: Loose Fixtures

🔴 Recommendation

The fixture is loose. Tightening is recommended to prevent leaking.

Recommendation: Contact a qualified plumbing contractor.

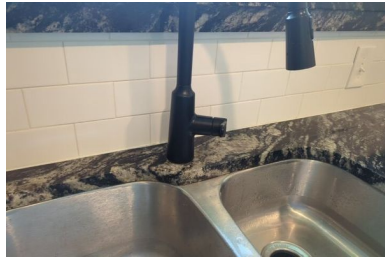

5: Toilet Loose - Floor

🔴 Recommendation

The toilet is loose at the floor, which can result in damage to the wax seal under the toilet and possible leakage.

Recommendation: Contact a qualified plumbing contractor.

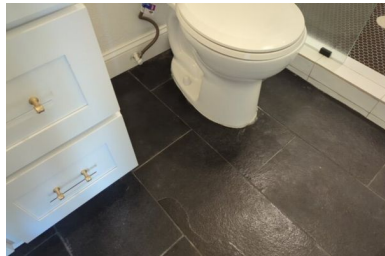

Master Bathroom

6: Faucet doesnt shut off properly

🔴 Recommendation

Master shower handle would not shuy off without nn

Recommendation: Contact a qualified professional.

I=Inspected

NI=Not Inspected

NP=Not Present

D=Deficient

I NI NP D



B. Drains, Wastes, and Vents

Comments:

Type of Drain Piping Material Observed: Cast Iron, PVC

Type of Drain Piping at Sinks: PVC

Cast Iron - Typical:

The typical drainage piping for this age of home is cast iron. Cast iron piping has been associated with problematic conditions and buyer may wish to have the drainage piping further evaluated by a licensed plumber. Note: cast iron drain lines are known to clog/leak over time and may require periodic cleaning. Inspection of the below surface sewer components is beyond the scope of this visual inspection. Scanning of the lines is the only way to assure there are no broken or clogged components. It is recommended all sewer lines 20 years or older be scanned before closing because finding and correcting these problems can be very expensive.

Sewer Camera Inspection:

A sewer camera inspection is recommended for the inspected address. The inside of the drainage piping is not visible during a typical home inspection. The purpose of a sewer camera is to be able view the inside of the drainage piping. With the camera, the qualified professional can observe a blockage or backup, check for tree roots, observe any broken or cracked pipes, or observed sagging or bellied areas in the pipes without digging up the yard or just guessing what the problem is. Sewer repairs and pipe replacements can be large and expensive tasks, this can help the homeowner avoid expensive repairs.

Overflows:

Tub and sink overflows, and extermination points were not inspected.

1: Accordion Piping

🔴 Recommendation

Accordion piping was present at the sink. Drainage piping should be smooth walled.

Recommendation: Contact a qualified plumbing contractor.

2: Stopper stuck closed

🔴 Recommendation

Recommendation: Contact a qualified professional.



Master Bathroom

I=Inspected NI=Not Inspected NP=Not Present D=Deficient

I	NI	NP	D
---	----	----	---

C. Water Heating Equipment

Comments:

Unit Information:

The National Association of Home Builders and Bank of America Home Equity division produced a Study of Life Expectancy of Home Components in February 2007. Life expectancy is based on first owner use.

That study noted that the expected life span (on average) of gas-fired heaters is about 18 years.

That study noted that the expected life span (on average) of electric heaters is about 15-20 years.

That study noted that the expected life span (on average of gas-fired tankless water heaters (on average) is about 20-25 years.

Take this into consideration when noting the manufacture date for the unit at this property. It is recommended that units of the above ages be further evaluated and cleaned to verify that the heat exchanger and/or heating elements are working properly.



Energy Source: Gas

WH Size: Tankless

WH Location: Laundry Room

TP Material: CPVC

WH Pan: No

Tankless Unit Service Information:

Tankless water heaters should be maintained by a licensed professional at least once a year. But, you may need to get your water heater serviced twice a year if:

1. The area you live in has hard water.
2. Your water heater is set to a high temperature.

A licensed professional should descale your water heater at least once a year.

Specific Limitations:

Note: Specific Limitations. The inspector is not required to:

- (A) verify the effectiveness of the temperature and pressure relief valve, discharge piping, or pan drain pipes;
- (B) operate the temperature and pressure relief valve if the operation of the valve may, in the inspector's reasonable judgment, cause damage to persons or property; or

(C) determine the efficiency or adequacy of the unit.

FYI: Recommend draining and flushing unit once per year to reduce deposits/noise, and extend life of unit.

Homes left vacant for extended periods of time may have a buildup of hydrogen sulfide gas inside the water tank. This gas causes an unpleasant "rotten eggs" odor. Generally, flushing the unit a few times will alleviate this problem. If problem persists contact a licensed plumber for further evaluation of the water heater.

*Manufacturer numbers are provided as additional information to the client. Appliances are not researched for recalls. If buyer has further concerns regarding recalls the appliance manufacturer should be contacted.

Temperature and Pressure Valve:

Valve is not operated due to possibility of causing leaks.

1: No Drip Leg/Sediment Trap

🚫 Recommendation

Drip leg or sediment trap was not observed on the gas line at the unit.

Recommendation: Contact a qualified plumbing contractor.

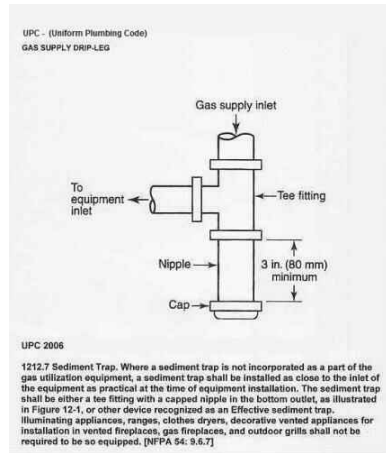

2: Flue Insufficient Clearance

⚠️ Safety Hazard

The vent pipe had insufficient clearance to combustible materials. Gas flues should have a clearance of 1.5" from building materials surrounding the flue pipe.

Recommendation: Contact a qualified plumbing contractor.



D. Hydro-Massage Therapy Equipment

Comments:

GFCI Present: N/A

Pump Access: N/A

Specific Limitations:

Note: FYI: Environmental testing of whirlpools is beyond the scope of this inspection. Health problems have been noted and directly linked to the bacterial growth in the distribution lines of the equipment.

Recommend that the manufacturer be consulted for further maintenance and cleaning instructions prior to use. For more information visit: www.whirlpoolcouncil.com

I=Inspected

NI=Not Inspected

NP=Not Present

D=Deficient

I NI NP D

E. Gas Distribution Systems and Gas Appliances

Comments:

Location of Gas Meter: Exterior



Type of Gas Distribution Piping Material: Black Iron

Areas of Rusting/Damage - Gas: No

Gas Line Pressure Testing:

Pressure testing gas lines or determining the condition of inaccessible or buried gas lines is beyond the scope of the inspection. This service is best provided by a licensed plumber. All gas lines within the structure and/or buried under ground were not inspected for condition and/or possible leakage. Only readily accessible gas line connections at the individual mechanical equipment are inspected for possible gas leakage. A Combustible Gas Leak Detector was used to check possible gas leaks at connections to any gas ranges, gas water heaters and gas central furnaces that might be present at the time of the inspection. If any concerns exist about possible gas line failure and/or deficiencies, it is recommended that the complete gas system be evaluated by the local controlling gas supplier and/or a licensed plumber. The gas utility company routinely performs gas leak tests as a part of establishing service.

I NI NP D

V. APPLIANCES

A. Dishwashers

Comments:

Appliance Information:



DW Back Flow: Not Present

Evidence of Leaks: No

1: Dishwasher Back Flow

🔴 **Recommendation**

The dishwasher drain line needs backflow prevention. A check valve, air gap or high loop could be installed on the drain line.

Recommendation: Contact a qualified appliance repair professional.

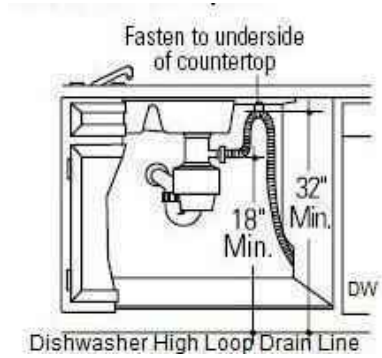
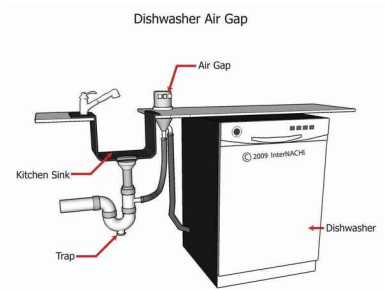

B. Food Waste Disposers

Comments:

Appliance Information:

I=Inspected NI=Not Inspected NP=Not Present D=Deficient

I	NI	NP	D
---	----	----	---



C. Range Hood and Exhaust Systems

Comments:

Appliance Information:



RH Vent: Vents to Exterior

1: Missing Light Bulb

Handyman/Maintenance Item

Light bulb was missing at the time of inspection.

Recommendation: Contact a qualified professional.

D. Ranges, Cooktops, and Ovens

Comments:

Appliance Information:



Oven Type: Gas

I=Inspected NI=Not Inspected NP=Not Present D=Deficient

I NI NP D

Range Type: Gas
Gas Line Access: No
Oven Heating Within 25 Degrees of 350: Yes

1: Gas Valve Not Accessible - Oven/Range

👉Recommendation

The gas shut off valve to the oven and range is not accessible. Due to this condition any emergency the owner would have to shut the gas off at the meter. The shut off should be accessible inside of the cabinet at either side of the stove.

E. Microwave Ovens

Comments:

Appliance Information:



Micro Heat: Yes

F. Mechanical Exhaust Vents and Bathroom Heaters

Comments:

Exhaust Fans In Bathroom: Yes
Exhaust Fan In Laundry: Operable Windows Present
Exhaust Fan Term Vent to Exterior: Undetermined
Termination Points:
Exhaust fan termination points were not able to be confirmed.

1: Cover Loose

👉Recommendation

Exhaust fan cover was loose at the time of inspection.

Recommendation: Contact a qualified professional.



G. Garage Door Operators

Comments:

I=Inspected NI=Not Inspected NP=Not Present D=Deficient

I NI NP D

Door Operated: N/A

Sensors 6 Inches Or Less From Garage Floor: N/A

Unit Operational: N/A

Electric Eye Reverse Test Acceptable: N/A

Auto Reverse Test:

Not Tested. The "Door Reversed When Obstructed Test" was not performed in order to avoid damage to door and operator.

H. Dryer Exhaust Systems

Comments:

Termination Location: Outside the structure

1: Screen Cover

🔴 Recommendation

The dryer vent is a screened type cover. This cover will restrict lint from exiting the duct and could contribute to clogging the duct. Replacement of the vent cover is recommended.

Recommendation: Contact a qualified professional.

I=Inspected

NI=Not Inspected

NP=Not Present

D=Deficient

I NI NP D

MISC.

Misc

Comments:

Pest Control:

The Structural Pest Control Act requires inspection of only those areas which are visible and accessible at the time of inspection. Some areas of the structure are not accessible to inspection, such as the interior of hollow walls, spaces between floors, areas concealed by carpeting, appliances, furniture or cabinets. Infestations may be active in these areas without visible and accessible evidence. If you desire information about areas that were not inspected, a further inspection may be performed at an additional cost. Carpets, furniture, or appliances are not moved during a routine inspection. Only a visual, non-invasive inspection is performed at the time of inspection. In conjunction with the inspection findings within this report, it is recommended that pest control service be utilized at the property for ongoing and/or preventative measures.

Previous WDI Treatment:

Evidence of a previous wood destroying insect treatment was observed.



Items Beyond the Inspection Scope:

Refrigerators Are Not Inspected.

Expansion tanks and recirculating pumps are not inspected.

Water filtration or softening systems are not inspected.

Instant hot water dispensers are not inspected.

Icemakers are not inspected.

Solar panels and systems are not inspected.

Ponds, streams, or other water areas are not inspected.

Whole house fans are not inspected or tested.

Whole house vacuum systems are not tested or inspected.

Saunas or steam rooms are not inspected.

Any landscape lighting, patio storage buildings, hot tubs, misting systems, security systems, surround sound systems/wiring, internet connections, and satellite systems that could be present are beyond the scope of this home inspection, and were not inspected.

Purpose: This is a one-time inspection of the subject property to identify and disclose visually observable major deficiencies of the inspected systems and items at the time of inspection only. Our comments are meant to educate and to provide our Client(s) with information about the areas in which the building or home may be deficient. Our intent is not to require every item below to be corrected by the seller. The buyer, seller, and their agents should use this report merely as a tool toward negotiation of a purchase and sell agreement.

Homes do not "Pass" or "Fail" an inspection.

This inspection is not to be technically exhaustive nor is it considered to be a guarantee or warranty, expressed or implied, regarding the conditions of the property.

I=Inspected NI=Not Inspected NP=Not Present D=Deficient

I NI NP D

Scope & Exclusions: This is a visual inspection only. We cannot see into, or behind, walls and we will not attempt to report on systems, items, or conditions that are not readily accessible. We do not disassemble anything. We do not inspect for any environmental issues such as RADON GAS, LEAD PAINT, FORMALDEHYDE, UREA, MOLDS, ASBESTOS, FUNGUS, SOIL CONTAMINATION, MICROWAVE RADIATION, or any other types of contaminants or microbiological organisms.

We do not inspect for building code compliance, building value, appraisal or cost estimates, soil analysis, adequacy of design, underground pipes or drains, capacity, efficiency, size, value, flood plain location, termite, pest or other real property destroying organisms, or habitability. Detached structures are not included in the inspection unless specifically agreed upon by both the inspector and the client. The above list of exclusions is not all inclusive. The Inspection report may comment on the exclusions noted above in a general fashion without incurring responsibility for the exclusions noted above in whole or part.

We do not move furniture, rugs, paintings, or other furniture. There is no responsibility expressed or implied for latent defects, or for defects not reasonably observable at the time of inspection, or for defects that would require the removal of major or permanent coverings for observation. No representation is made as to the future performance of any item. Inspection of water wells, septic systems, security systems, or fire protection equipment (other than smoke detectors) will not be inspected where state /city / county codes, special training, or certification may be additionally required.

We do not hold ourselves to be specialists for any particular item; nor are we engineers. We are a general real estate inspection company.

PLEASE NOTE: GreenWorks does not inspect for MOLD, MILDEW, FUNGUS and / or SPORES as a part of the standard Texas Real Estate Commission Inspection, UNLESS a separate mold inspection has been ordered PRIOR to date of Standard Home Inspection. If conditions of water penetration and / or migration are reported, it is assumed that conditions can and may exist that would support MOLD, MILDEW, FUNGUS and / or SPORES. While the condition of water penetration and / or migration, if visible and accessible, would be reported to the consumer, the condition of MOLD, MILDEW, FUNGUS and / or SPORES would not be tested, or inspected for. Mold inspections are separate inspections, and require a licensed Mold specialist to comment on, and test for, and report on the presence/absence of Mold, Mildew, Fungus, and spores.

Locked gates:

One or more gates were locked and not tested

1: Fence Damage

🔴Recommendation

Damage noted to the fence around the home. Recommend a qualified fence contractor evaluate and repair.

Recommendation: Contact a qualified fencing contractor

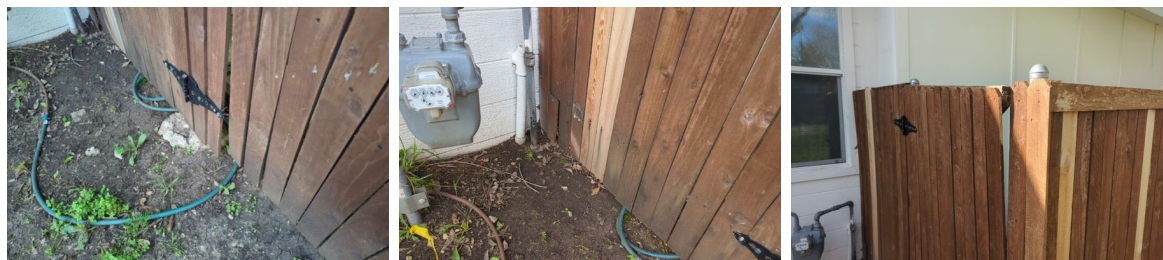

2: Fence Leaning

🔴Recommendation

I=Inspected

NI=Not Inspected

NP=Not Present

D=Deficient

I NI NP D

The fence around the home was observed to be leaning. Recommend a qualified fence contractor evaluate and repair.

Recommendation: Contact a qualified fencing contractor



3: Cabinet Damage

🔴 Recommendation

Observed damage to some cabinets within the property. Recommend a qualified professional evaluate and repair.

Recommendation: Contact a qualified cabinet contractor.



4: Wood Destroying Insect (WDI) Activity Observed

🔴 Recommendation

There were areas of wood destroying insect activity at the home. It is recommended that a treatment be performed.

Recommendation: Contact a qualified pest control specialist.



5: Driveway Cracking

🔧 Handyman/Maintenance Item

Cracking was observed at the driveway. Recommend a qualified professional evaluate and repair as needed.

Recommendation: Contact a qualified professional.

I=Inspected

NI=Not Inspected

NP=Not Present

D=Deficient

I	NI	NP	D
---	----	----	---



6: Driveway Settle

🔴 Recommendation

The driveway has settled away from the house.

Recommendation: Contact a qualified professional.



I=Inspected

NI=Not Inspected

NP=Not Present

D=Deficient

I	NI	NP	D
----------	-----------	-----------	----------

FINAL CHECKLIST

- Oven/Range Turned Off:* Yes
- Lights Turned Off:* No - Realtor Present
- Exterior Doors Locked:* No - Realtor Present
- Thermostat Initial Setting:* 65 Degrees Fahrenheit
- Thermostat Leaving Setting:* 65 Degrees Fahrenheit
- Sprinkler System Initial Setting:* N/A
- Sprinkler System Departure Setting:* N/A